

The Effect of Repair/Rewinding on Motor Efficiency

**EASA/AEMT Rewind Study
and
Good Practice Guide To Maintain Motor Efficiency**



*Reliable Solutions
Today!*



The Effect Of Repair/Rewinding On Motor Efficiency

EASA/AEMT Rewind Study

and

***Good Practice Guide
To Maintain Motor Efficiency***



Electrical Apparatus Service Association, Inc.
1331 Baur Boulevard
St. Louis, Missouri 63132 U.S.A.
314-993-2220 • Fax: 314-993-1269
easainfo@easa.com • www.easa.com

Association of Electrical and Mechanical Trades (AEMT Ltd)
Co. Reg. No. 00397289 (England and Wales)
St. Saviours House
St. Saviours Place
York, YO1 7PJ
England, UK
44 (0) 1904 674897 • Fax: 44 (0) 1904 674896
admin@aemt.co.uk • www.aemt.co.uk

Copyright © 2003. St. Louis, Missouri USA
and York, England UK. All rights reserved.

Disclaimer

The information in this report and the *Good Practice Guide to Maintain Motor Efficiency* (Part 2) was carefully prepared and is believed to be correct but neither EASA nor the AEMT make any warranties respecting it and disclaim any responsibility or liability of any kind for any loss or damage as a consequence of anyone's use of or reliance upon such information.

(This page intentionally left blank.)

Foreword

This publication contains an *Executive Summary* and a comprehensive report on the results of the EASA/AEMT rewind study (Part 1); a *Good Practice Guide to Maintain Motor Efficiency* (Part 2); and *Further Reading* (Part 3). Its organization assumes a diverse group of readers whose interest in these subjects will vary widely—e.g., plant managers, purchasing agents, representatives of government agencies, engineers, and service center technicians. Accordingly, some of the material may not be of interest to all of them.

Acknowledgments

Principal Contributors

- John Allen
- Thomas Bishop
- Austin Bonnett
- Brian Gibbon
- Alan Morris
- Cyndi Nyberg
- David Walters
- Chuck Yung

Project Sponsors

- Electrical Apparatus Service Association, Inc. (EASA)
- Association of Electrical and Mechanical Trades (AEMT)

- British Nuclear Fuels (BNF)
- United States Department of Energy (DOE)
- Energy Efficient Best Practice Program (EEBPP), UK
- Ministry of Defense Ships Support Agency (MoD SSA), UK
- UK Water Industry Research, Ltd. (UKWIR)

Participating Manufacturers and Institutions

- Ten motor manufacturers provided motors, technical data and assistance for the study: ABB, Baldor, Brook Crompton, GEC, Leeson, Reliance, Siemens, Toshiba, U.S. Electrical Motors and VEM.
- The Dowding and Mills facility in Birmingham, UK, carried out all motor rewinds and repairs.
- The University of Nottingham performed efficiency testing on their dynamometers in Nottingham, UK.

Acronyms

The acronyms of additional organizations that played an important role in the publication of this document are shown below.

ANSI—American National Standards Institute

CSA—Canadian Standards Association

IEC—International Electrotechnical Commission

IEEE—Institute of Electrical and Electronics Engineers, Inc.

NEMA—National Electrical Manufacturers Association

UL—Underwriters Laboratories, Inc.

BS—British Standards

EN—European Standard

Please direct questions and comments about the rewind study and the Good Practice Guide to EASA, 1331 Baur Boulevard, St. Louis, Missouri 63132; 314-993-2220; Fax: 314-993-1269; easainfo@easa.com.

(This page intentionally left blank.)

Table of Contents

Part 1: *EASA/AEMT Rewind Study*

Executive Summary	1-3
Test Protocol & Results	1-9

Part 2: *Good Practice Guide To Maintain Motor Efficiency*

Introduction	2-3
Terminology	2-3
Energy Losses in Induction Motors	2-4
Motor Repair Processes	2-10

Part 3: *Further Reading*

Bibliography	3-3
Appendix 1: Chord Factor and Distribution Factor	3-4
Appendix 2: Analysis of Winding Configurations	3-6
Appendix 3: Changing To Lap Windings—Examples	3-7
Appendix 4: Electrical Steels	3-9
Appendix 5: Repair—Replace Considerations	3-17

(This page intentionally left blank.)

Part 1: *EASA/AEMT Rewind Study*

Executive Summary 1-3

Test Protocol & Results 1-9

 Test Protocol–Key Points 1-9

 Comparison of IEC 60034-2 and IEEE 112-1996 Load Testing Methods 1-11

 Loss Segregation Methods Used in EASA/AEMT Rewind Study 1-13

 Core Loss Testing 1-15

 Test Data 1-16

(This page intentionally left blank.)

Executive Summary

The Effect of Repair/Rewinding On Motor Efficiency

Introduction

Electric motors are key components in most industrial plants and equipment. They account for two-thirds of all the electrical energy used by industrial/commercial applications in the developed world with lifetime energy costs normally totaling many times the original motor purchase price. In Europe and the USA alone, the annual cost of energy used by motors is estimated at over \$100 billion (U.S.). Yet motor failure can cost more in terms of lost production, missed shipping dates and disappointed customers. Even a single failure can adversely impact a company's short-term profitability; multiple or repeated failures can reduce future competitiveness in both the medium and long term.

Clearly, industrial companies need effective motor maintenance and management strategies to minimize overall motor purchase and running costs while avoiding the pitfalls caused by unexpected motor failures.

Experienced users long have known that having motors repaired or rewound by a qualified service center reduces capital expenditures while assuring reliable operation. Rising energy costs in recent years, however, have led to questions about the energy efficiency of repaired/rewound motors.

To help answer these questions, the Electrical Apparatus Service Association (EASA) and the Association of Electrical and Mechanical Trades (AEMT) studied the effects of repair/rewinding on motor efficiency. This *Executive Summary* briefly describes the methodology and results of this study. The remainder of Part 1 provides additional details and test data. A *Good Practice Guide to Maintain Motor Efficiency* (Part 2) that identifies procedures for maintaining or even improving the efficiency of motors after rewind is also included.

Background

Simple, robust and efficient, induction motors often convert 90% - 95% of input electrical power into mechanical work. Still, given the huge amount of energy they use, even minor changes in efficiency could have a big effect on operating costs.

Over the past two decades, rising energy costs and governmental intervention have led to significant improvements in motor efficiency. In the USA, for example, the Energy Policy Act of 1992 (EPAAct) and new premium efficiency designs have boosted efficiency levels to the highest currently available. In Europe, voluntary agreements among leading motor manufacturers and the European Commission (EC) are aiming at the same result with EFF1 category motors.

Meanwhile, claims that repair/rewinding inevitably decreases motor efficiency have been commonplace. Based largely on a handful of studies of mostly smaller motors (up

to 30 hp or 22.5 kW), they often assert that efficiency drops 1 - 5% when a motor is rewound—even more with repeated rewinds [Refs. 1-5]. This perception persists, despite evidence to the contrary provided by a more recent study by Advanced Energy [Ref. 6].

In this context, decision makers today are carefully evaluating both the reliability and the efficiency of the motors they buy or have repaired. The difficulty they face, however, is how to separate fact from fiction, reality from myth.

Objectives

EASA and AEMT designed this study to find definitive answers to efficiency questions, particularly as regards repaired/rewound motors. The primary objective of the project was to determine the impact of rewinding/repair on induction motor efficiency. This included studying the effects of a number of variables:

- Rewinding motors with no specific controls on stripping and rewind procedures.
- Overgreasing bearings.
- How different burnout temperatures affect stator core losses.
- Repeated rewinds.
- Rewinding low- versus medium-voltage motors.
- Using different winding configurations and slot fills.
- Physical (mechanical) damage to stator core.

A second goal was to identify procedures that degrade, help maintain or even improve the efficiency of rewound motors and prepare a *Good Practice Guide to Maintain Motor Efficiency* (Part 2).

A final objective was to attempt to correlate results obtained with the running core loss test and static core loss tests.

This research focused on induction motors with higher power ratings than those in previous studies (i.e., those most likely to be rewound), subjecting them to independent efficiency tests before and after rewinding. Throughout this study EASA and the AEMT have sought a balanced approach that takes account of practical constraints and overall environmental considerations.

The results of tests carried out by Nottingham University (UK) for EASA and the AEMT show that good practice repair methods maintain efficiency to within the range of accuracy that it is possible to measure using standard industry test procedures ($\pm 0.2\%$), and may sometimes improve it. The accompanying report also identifies the good practice repair processes and provides considerable supporting information.

Scope of Products Evaluated

The study involved 22 new motors ranging from 50 to

300 hp (37.5 to 225 kW) and 2 smaller motors [7.5 hp (5.5 kW)]. These included:

- 50 and 60 Hz motors
- Low- and medium-voltage motors
- IEC and NEMA designs
- Open drip-proof (IP 23) and totally enclosed fan-cooled (IP 54) enclosures
- 2- and 4-pole motors
- 7.5 hp (5.5 kW) motors (for checking earlier results of multiple burnout cycles)
- Round robin tests on a new 40 hp (30 kW) motor, which indicate that such factors as supply voltage, repeatability of the test procedures, and instrumentation, taken together, can affect test results.

Methodology

All tests were carried out in accordance with IEEE Standard 112 Method B using a dynamometer test rig (see Figure 1). Instrumentation accuracy exceeded that required by the Standard. A new 40 hp (30 kW) motor was tested at four different locations (see side-bar “Round Robin Testing and Test Protocol”) to verify the accuracy of the test equipment and methods used by Nottingham University. For comparison, efficiencies also were calculated in accordance with BS EN 60034-2, which is the current standard in Europe.

Each new motor was run at full load until steady-state conditions were established and then load tested, dismantled and the windings burned out in a controlled-temperature burnout oven. Each motor was then stripped, rewound, reassembled and retested using the same test equipment as before. In most cases, core losses

Figure 1

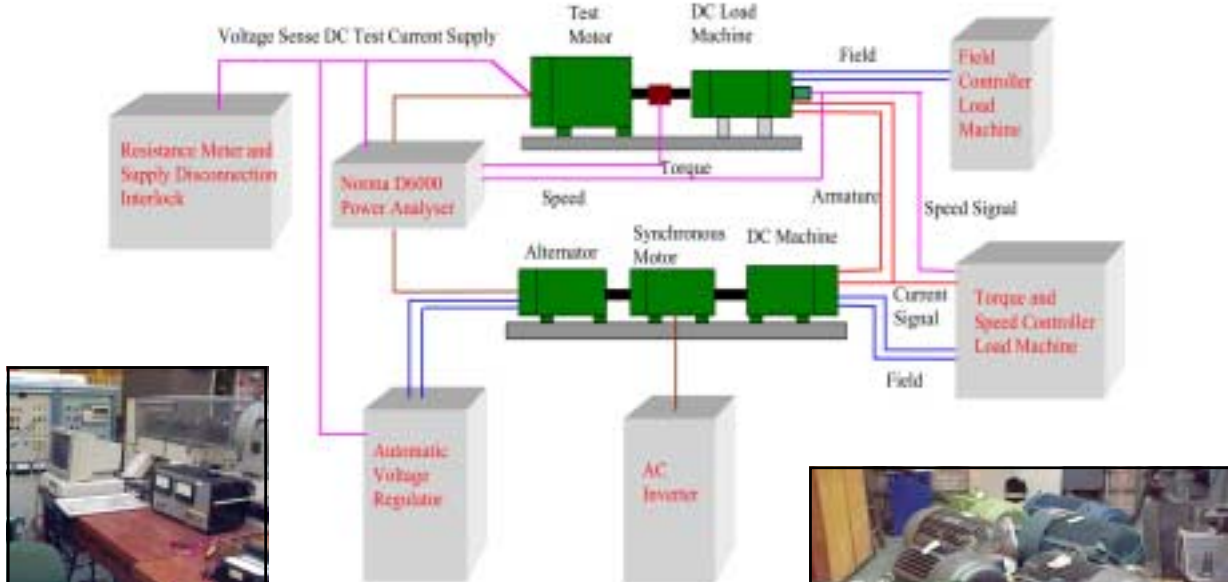

were measured before burnout and after stripping using a loop (ring) test and/or two commercial core loss testers.

Results of Efficiency Tests on Rewound Motors

The 22 new motors studied were divided into four groups to accommodate the different test variables. The test results summarized below show no significant change in the efficiency of motors rewound using good practice repair procedures (within the range of accuracy of the IEEE 112B test method), and that in several cases efficiency actually increased. (For detailed test results, see "EASA/AEMT Test Protocol & Results" on Pages 1-7 to 1-19.)

Group A Six low-voltage motors [100 - 150 hp (75 - 112 kW)] rewound once. No specific controls on stripping and rewind processes with burnout temperature of 660° F (350° C).

Results: Initially showed **average efficiency change of -0.6% after 1 rewind (range -0.3 to -1.0%)**.

However, two motors that showed the greatest efficiency reduction had been relubricated during assembly, which increased the friction loss.

After this was corrected the **average efficiency change was -0.4% (range -0.3 to -0.5%)**.

Group B Ten low-voltage motors [60 - 200 hp (45 - 150 kW)] rewound once. Controlled stripping and rewind processes with burnout temperature of 680° F - 700° F (360° C - 370° C).

Results: **Average efficiency change of -0.1% (range +0.2 to -0.7%)**.

One motor was subsequently found to have faulty interlaminar insulation as supplied. Omitting the result from this motor, the **average efficiency change was -0.03% (range +0.2 to -0.2%)**.

Group C1 Five low-voltage motors [100 - 200 hp (75 - 150 kW)] rewound two or three times. Controlled stripping and rewind processes with burnout temperature of 680° F - 700° F (360° C - 370° C).

Results: **Average efficiency change of -0.1% (range +0.7 to -0.6%)** after 3 rewinds (3 machines) and 2 rewinds (2 machines).

Group C2 Two low-voltage motors [7.5 hp (5.5 kW)] processed in burnout oven three times and rewound once. Controlled stripping and rewind processes with burnout temperature of 680° F - 700° F (360° C - 370° C).

ROUND ROBIN TESTING AND TEST PROTOCOL

To ensure accurate test results, a 30 kW IEC motor was efficiency tested first by the University of Nottingham and then by three other test facilities. The other facilities were: U.S. Electrical Motors, St. Louis, Missouri; Baldor Electric Co., Fort Smith, Arkansas; and Oregon State University, Corvallis, Oregon.

Each facility tested the motor at 50 and 60 Hz using the IEEE 112 Method B (IEEE 112B) test procedure. All testing used the loss-segregation method (at no load and full load), which allowed for detailed analysis.

As a benchmark, the results were compared with those of round robin test programs previously conducted by members of the National Electrical Manufacturers Association (NEMA). Initial results of NEMA's tests varied by 1.7 points of efficiency; the variance subsequently was reduced to 0.5 points of efficiency by standardizing test procedures.

As Table 1 shows, the range of results for round robin tests of the 30 kW motor in this study did not exceed 0.9 points of efficiency at 60 Hz, and 0.5 points at 50 Hz. These results were achieved without standardization and compare favorably with the 1.7% variation of the NEMA tests.

These results also verify that the test protocol for determining the impact of rewinding on motor efficiency is in accord with approved industry practice, and that the results obtained in this study are not skewed by the method of evaluation.

**TABLE 1
ROUND ROBIN TEST RESULTS OF 30 KW, 4-POLE MOTOR**

Test location	Test	Full load efficiency	Full load power factor	Full load amps	Temperature rise	rpm
Baldor	400v/50 Hz	91.8%	86.8%	54.0	69.4° C	1469
Nottingham	400v/50 Hz	92.3%	87.0%	54.2	68.0° C	1469
U.S. Electrical Motors	400v/50 Hz	91.9%	86.7%	53.5	59.0° C	1470
Nottingham	460/60 Hz	93.5%	85.9%	47.0	53.9° C	1776
Oregon State	460v/60 Hz	92.6%	85.9%	47.0	50.0° C	1774
U.S. Electrical Motors	460v/60 Hz	93.1%	86.4%	46.5	42.0° C	1774

Results: Average efficiency change of +0.5% (range +0.2 to +0.8%).

Group D One medium-voltage motor [300 hp (225 kW)] with formed stator coils rewound once. Controlled stripping and rewind processes with burnout temperature of 680° F - 700° F (360° C - 370° C).

Results: Efficiency change of -0.2%. The behavior of this motor was similar to the low-voltage machines rewound with specific controls.

Significance of Tests Results

The test results for all groups fall within the range of the deviation of the round robin tests, indicating that test procedures were in accordance with approved industry practice (see side-bar on “Round Robin Testing”).

The average efficiency change for each group also falls within the range of accuracy for the test method ($\pm 0.2\%$), showing that motors repaired/rewound following good practices maintained their original efficiency, and that in several instances efficiency actually improved. (See side-bar “Explanation of Nameplate Efficiency.”)

All motors were burned out at controlled temperatures. Other specific controls applied to motors (except those in

Group A) included control of core cleaning methods and rewind details such as turns/coil, mean length of turn, and conductor cross sectional area.

The benefits of these controls, which form the basis of the *Good Practice Guide to Maintain Motor Efficiency* (Part 2), are clearly shown in Figure 2, which compares the results for motors in Groups A and B.

Conclusion

This report is the work of a team of leading international personnel from industry and academia. The results clearly demonstrate that motor efficiency can be maintained provided repairers use the methods outlined in the *Good Practice Guide to Maintain Motor Efficiency* (Part 2).

Partial List of Supporting Information Provided Elsewhere in This Publication

- **EASA/AEMT Test Protocol & Results (Part 1).** This includes a full account of the details of the study, as well as actual test data. In addition, this section explains in simple terms how motor losses were calculated for this study in accordance with IEEE 112 Method B, widely recognized as one of the most accurate test standards currently in use. It also summarizes the main differences between the IEC test standard (BS EN 60034-2) and IEEE 112-1996 and compares the motor efficiencies measured for this project but calculated by the two different methods. Finally, this section demonstrates that tests commonly used by service centers are effective in determining if repair processes (particularly winding burnout and removal) have affected motor efficiency.
- **Good Practice Guide to Maintain Motor Efficiency (Part 2).** Intended primarily for service center personnel, this outlines the good practice repair methods used to achieve the results given in this study. It can be used as a stand-alone document. It also contains repair tips, relevant motor terminology, and information about sources of losses in induction motors that affect efficiency. Included, too, is a useful analysis of stray load loss, which is currently treated differently in IEC and IEEE motor test standards.
- **Appendix 4: Electrical Steels.** The type of electrical steel and interlaminar insulation chosen for the stator and rotor laminations are very important in determining motor performance and efficiency. Improper repair processes, however, can alter the qualities of the steel core and its interlaminar insulation. This appendix reviews the various types of electrical steel used throughout the world and explains in greater detail the reasons for some of the good practices suggested in Part 2.
- **Appendix 5: Repair or Replace?.** This often difficult question is covered comprehensively here. Replacing a motor with a new one of higher efficiency is often the best financial option. At other times, repairing the existing motor will yield better results. Key factors include annual running hours, the availability of a suitable high efficiency replacement motor, downtime, and reliability. This chapter also contains charts that can help both users and repairers make the best choice.

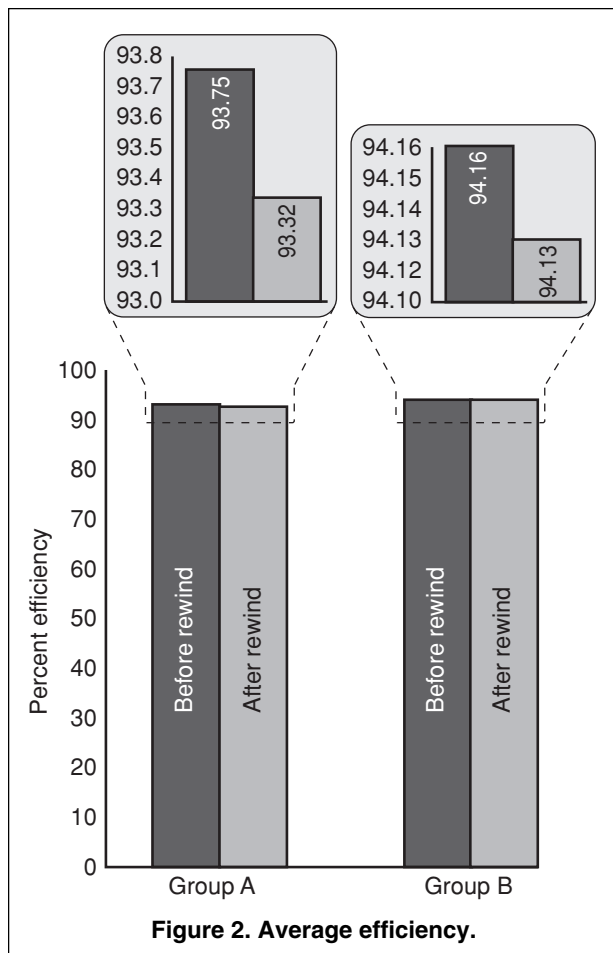

Figure 2. Average efficiency.

EXPLANATION OF NAMEPLATE EFFICIENCY

Nameplate efficiency is the benchmark for comparing efficiencies before and after a motor rewind. It is important to understand the basis for and limitation of nameplate values.

The nameplate may state the nominal efficiency, the minimum (also called “guaranteed”) efficiency, or both. If only one is listed, it usually is the nominal value, which always has an associated minimum value (to allow for higher losses). If no efficiency is shown on the nameplate, contact the motor manufacturer or consult catalogs or technical literature.

Nominal and minimum efficiencies are best understood as averages for particular motor designs—not as actual tested efficiencies for a particular motor. They are derived by testing sample motors of a single design.

As Tables 2 and 3 show, the efficiencies for NEMA and IEC motors cover a range of values (between the minimum and nominal efficiencies). They are not discrete values. Consequently, it can be misleading to compare the tested efficiency of a new or rewound motor with its nameplate efficiency.

The minimum efficiency is based on a “loss difference” of 20% for NEMA motors and 10 or 15% for IEC motors. This allows for variations in material, manufacturing processes, and test results in motor-to-motor efficiency for a given motor in a large population of motors of a single design.

Nominal and minimum efficiency values are only accurate at full load, with rated and balanced sinusoidal voltage and frequency applied at sea level and at an ambient of 25° C. Therefore, it usually is impractical to measure efficiency in situ to the levels of accuracy implied by the three significant figures that may be shown on the nameplate. The fact that the tested efficiency does not match the nominal nameplate efficiency does not imply that the motor was made or repaired improperly.

Figures 2 and 3 show typical nameplates for IEC and NEMA motors.

Reference: NEMA MG 1-1998 (Rev. 3).

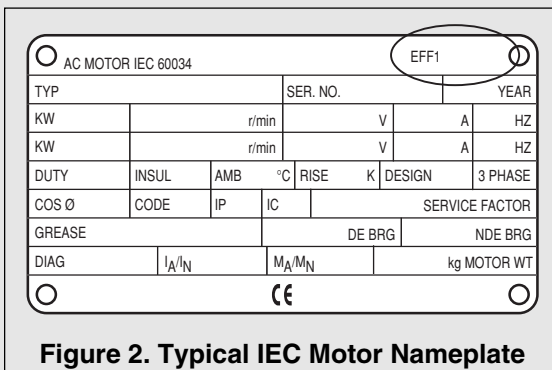

Figure 2. Typical IEC Motor Nameplate

Nominal Efficiency	Minimum Efficiency Based on 20% Loss Difference
94.1	93.0
93.6	92.4
93.0	91.7
92.4	91.0
91.7	90.2
91.0	89.5
90.2	88.5
89.5	87.5
88.5	86.5
87.5	85.5

Reference: NEMA MG 1-1998 (Rev. 3), Table 12-10.

Nominal Efficiency	Minimum Efficiency <50 kW (15% Loss Difference)	Minimum Efficiency >50 kW (20% Loss Difference)
94.1	93.3	93.5
93.6	92.7	93.0
93.0	92.0	92.3
92.4	91.3	91.6
91.7	90.5	90.9
91.0	89.7	90.1
90.2	88.7	89.2
89.5	87.9	88.5
88.5	86.2	87.4
87.5	85.9	86.3

Reference: IEC 60034-1, Table 18. Nominal and minimum efficiencies for IEC motors measured by summation of loss method.

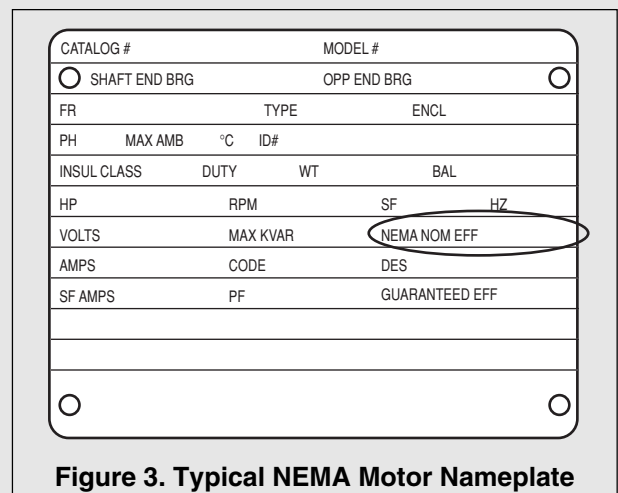

Figure 3. Typical NEMA Motor Nameplate

References

- [1] William U. McGovern, "High Efficiency Motors for Upgrading Plant Performance," *Electric Forum* 10, No. 2 (1984), pp. 14-18.
- [2] Roy S. Colby and Denise L. Flora, *Measured Efficiency of High Efficiency and Standard Induction Motors* (North Carolina State University, Department of Electrical and Computer Engineering (IEL), 1990).
- [3] D. H. Dederer, "Rewound Motor Efficiency," *Ontario Hydro Technology Profile* (Ontario Hydro, November 1991).
- [4] Zeller, "Rewound High-Efficiency Motor Performance," *Guides to Energy Management* (BC Hydro, 1992).
- [5] *Rewound Motor Efficiency, TP-91-125* (Ontario Hydro, 1991).
- [6] Advanced Energy, "The Effect of Rewinding on Induction Motor Losses and Efficiency" (EEMODS 02, 2002).

EASA/AEMT Test Protocol & Results

TEST PROTOCOL—KEY POINTS

Experienced users long have known that having motors repaired or rewound by a qualified service center reduces capital expenditures while assuring reliable operation. Rising energy costs in recent years, however, have led to questions about the energy efficiency of repaired/rewound motors. To help answer these questions, the Electrical Apparatus Service Association (EASA) and the Association of Electrical and Mechanical Trades (AEMT) studied the effects of repair/rewinding on motor efficiency.

Objectives of the Study

The primary objective of the study was to provide the most accurate assessment possible of the impact of motor repair on rewinding. This included studying the effects of a number of variables:

- Rewinding motors with no specific controls on stripping and rewind procedures.
- Overgreasing bearings.
- Different burnout temperatures on stator core losses.
- Repeated rewinds.
- Rewinding low- versus medium-voltage motors.
- Using different winding configurations and slot fills.
- Physical (mechanical) damage to stator core.

A second goal was to identify procedures that degrade, help maintain or even improve the efficiency of rewound motors and prepare a *Good Practice Guide to Maintain Motor Efficiency* (Part 2).

A final objective was to attempt to correlate results obtained with the running core loss test and static core loss tests.

Products Evaluated

This research focused on induction motors with higher power ratings than those in previous studies (i.e., those most likely to be rewound), subjecting them to independent efficiency tests before and after rewinding [Refs. 1 - 6].

Twenty-two new motors ranging from 50 to 300 hp (37.5 to 225 kW) and 2 smaller motors [7.5 hp (5.5 kW)] were selected for the study. These included:

- 50 and 60 Hz motors
- Low- and medium-voltage motors
- IEC and NEMA designs
- Open dripproof (IP 23) and totally enclosed fan-cooled (IP 54) enclosures
- 2- and 4-pole motors

- 7.5 hp (5.5 kW) motors (for checking earlier results of multiple burnout cycles)
- Round robin tests on a new 40 hp (30 kW) motor, which indicate that such factors as supply voltage, repeatability of the test procedures, and instrumentation, taken together, can affect test results.

Standards for Evaluating Losses

Two principal standards are relevant to this work. IEC 60034-2 is the current European standard (BS EN 60034-2 is the British version), and IEEE 112 is the American standard. The IEEE standard offers several methods of translating test results into a specification of motor efficiency. IEEE 112 Method B (IEEE 112B) was used for this study because it provides an indirect measurement of stray load loss, rather than assuming a value as the IEC standard does. IEEE 112B therefore measures efficiency more accurately than the IEC method.

Both IEC 60034-2 and IEEE 112B efficiency test procedures require no-load, full-load and part-load tests. The IEEE approach requires no-load tests over a range of voltages and a wider range of loads for the part-load conditions. The IEEE 112B also requires precise torque measurement, whereas the IEC test does not.

Although the study was conducted in accordance with IEEE 112B test procedures, the results are quoted to both IEC and IEEE standards. Interestingly, the most significant difference between them is in the area of stray load loss. (For an in-depth comparison of IEEE 112B and IEC 60034-2, see Page 1-12; and for an explanation of loss segregation according to IEEE 112-1996, see Page 1-14.)

Methodology

All tests were carried out in accordance with IEEE 112B using a dynamometer test rig (see Figure 1). Instrumentation accuracy exceeded that required by the standard. A new 40 hp (30 kW) motor was tested at four different locations (see “Round Robin Testing” on Page 1-11) to verify the accuracy of the test equipment and methods used by Nottingham University. For comparison, efficiencies also were calculated in accordance with BS EN 60034-2, which is the current standard in Europe (see Page 1-14 for discussion of IEEE and IEC methods for calculating stray load losses).

Each motor was initially run at full load until steady-state conditions were established and then load tested. The motors were then dismantled, the stators were processed in a controlled-temperature oven, and the windings were removed. Next, each motor was rewound, reassembled and retested using the same test equipment as before. In most cases, core losses were measured before burnout and after coil removal using a loop (ring) test and/or two commercial core loss testers. To minimize performance changes due to factors other than normal rewind procedures, rotor assemblies were not changed.

Potential Sources of Error

Ideally, the electrical supply to a machine under test should be a perfectly sinusoidal and balanced set of three-phase voltages. Unbalance in the phase voltages (line-to-line as only three wire supplies are used) or imperfection in the 120 electrical degree phase difference between adjacent phases will increase machine losses. Although losses change with the changing unbalance during the day in the normal supply system, phase voltage regulation can mitigate this.

The presence of voltage harmonics or distortion in the supply also will increase the power loss in a machine. The considerable distortion present on normal mains supplies changes constantly throughout the day and from day to day.

Such potential sources of error were avoided in this project by rigorously adhering to the IEEE 112B test procedures and using a well-designed test rig.

Repeatability of Results

Although accuracy of the highest order obviously was required, repeatability was even more important. Therefore, the test rig for this project (Figure 1) was designed to control three of four basic factors that contribute to repeatability: the power supply system, the mechanical loading system, and the instrumentation. The fourth variable, test procedures, is discussed separately below.

Test rig and equipment. The test equipment used by the University of Nottingham consisted of a DC load machine that was coupled to the test motor by a torque transducer mounted in a universal joint. The AC supply to the test motors was provided by an AC generator that was driven by an inverter-fed synchronous motor. This setup provided a constant sinusoidal voltage of almost perfect balance and waveform purity. A second DC machine was coupled to the same shaft as the generator and synchronous motor to

Figure 1. Schematic of Test Rig Used for IEEE 112 Method B Tests

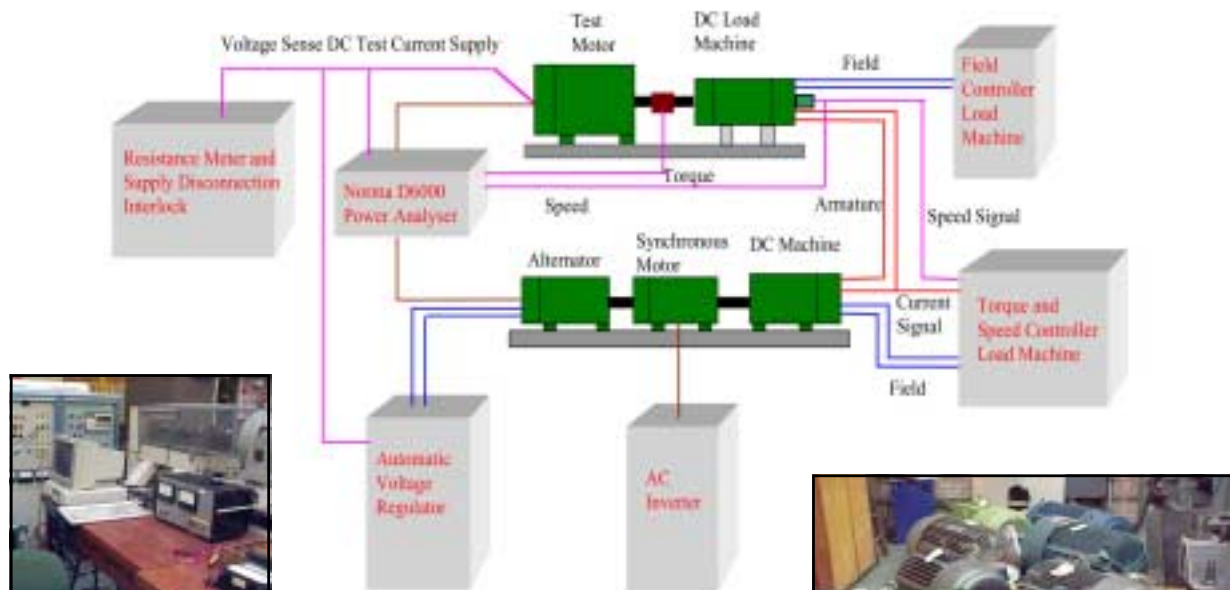

reclaim energy from the DC load machine.

A range of in-line torque transducers was employed in each rig to ensure maximum accuracy. Power, voltage, current, speed and torque were measured with a Norma D6000 wattmeter with motor option. All torque, speed and power readings were taken at the same instant and averaged over several slip cycles to minimize reading fluctuations. The winding resistance was measured at the motor terminals with a four-wire Valhalla electronic bridge with a basic accuracy of 0.02%.

The test setup therefore controlled three of the four potential sources of error—power supply, loading system and test equipment. That leaves just one—test procedures.

Test procedures. The tests for this study were performed in accordance with IEEE 112B. Test procedures, measurement intervals, and thermocouple location on the winding were optimized by comparing results for a 30 kW test motor with those obtained using direct measurement of loss by calorimeter.

As a precursor to the load test, each motor completed an entire thermal cycle of the test machine, running at full load until the temperature stabilized and the grease in the bearings settled. Typically, this took a minimum of four hours at load. The machine was then allowed to cool to room temperature.

No-load tests were essentially conducted at the temperature of the motor associated with constant, no-load, rated voltage operation. Winding temperatures were measured by thermocouples embedded in the coil extensions.

Once temperatures stabilized, a set of electrical and mechanical results was taken, and winding temperatures and resistance were determined. The test motor was then returned to full-load operation to restore the full-load temperature. Next, part-load readings were taken, starting with the highest load and working down to the lightest load. Readings were taken quickly in each case, after allowing a very brief interval for the machine to settle to its new load.

The techniques and equipment described above ensured **repeatability to within 0.1%** for tests conducted on a stock motor at intervals of several months. A 100 hp (75 kW) motor without any modifications was kept especially for this purpose.

Round Robin Testing of 30 kW IEC Motor

As an additional check to ensure accurate test results, a 30 kW IEC motor was efficiency tested first by the University of Nottingham and then by three other test facilities. The other facilities were: U.S. Electrical Motors, St. Louis, Missouri; Baldor Electric Co., Fort Smith, Arkansas; and Oregon State University, Corvallis, Oregon.

Each facility tested the motor at 50 and 60 Hz using the IEEE 112B test procedure. All testing used the loss-segregation method (at no load and full load), which allowed for detailed analysis.

As a benchmark, the results were compared with those of round robin test programs previously conducted by members of the National Electrical Manufacturers Association (NEMA). Initial results of NEMA's tests varied by 1.7 points of efficiency; the variance subsequently was reduced to 0.5 points of efficiency by standardizing test procedures.

As Table 1 shows, the range of results for round robin tests of the 30 kW motor in this study did not exceed 0.9 points of efficiency at 60 Hz, and 0.5 points at 50 Hz. These results were achieved without standardization and compare favorably with the 1.7% variation of the non-standardized NEMA tests.

These results also verify that the test protocol for determining the impact of rewinding on motor efficiency is in accord with approved industry practice, and that the results obtained in this study are not skewed by the method of evaluation.

COMPARISON OF IEC 60034-2 AND IEEE 112-1996 LOAD TESTING METHODS

The IEEE 112B test procedure was selected over IEC method 60034-2 for the EASA/AEMT rewind study because it measures motor efficiency more accurately. Many of the differences between the two methods are explained below and illustrated in Tables 2 - 7.

The most significant difference between the two methods, however, is how they determine stray load loss (SLL). IEEE 112B uses the segregated loss method, which is explained more fully on Page 1-14. IEC 60034-2 assumes a loss of 0.5% of the input power at rated load, which is

**TABLE 1
ROUND ROBIN TEST RESULTS OF 30 KW, 4-POLE MOTOR**

Test location	Test	Full load efficiency	Full load power factor	Full load amps	Temperature rise	rpm
Baldor	400v/50 Hz	91.8%	86.8%	54.0	69.4° C	1469
Nottingham	400v/50 Hz	92.3%	87.0%	54.2	68.0° C	1469
U.S. Electrical Motors	400v/50 Hz	91.9%	86.7%	53.5	59.0° C	1470
Nottingham	460v/60 Hz	93.5%	85.9%	47.0	53.9° C	1776
Oregon State	460v/60 Hz	92.6%	85.9%	47.0	50.0° C	1774
U.S. Electrical Motors	460v/60 Hz	93.1%	86.4%	46.5	42.0° C	1774

assumed to vary as the square of the stator current at other load points. The effect can be to overstate the level of efficiency by up to 1.5 points, depending on what percent of the total loss is represented by the stray load loss. The differences in EASA/AEMT rewind study were less (see Table 7).

TABLE 2. METHODS

IEEE 112B	IEC 60034-2
Input - output	Braking test
Input - output with loss segregation Indirect measurement of stray load loss	—
Duplicate machines	Mechanical back-to-back
Electrical power measurements under load with segregation of losses 1) Direct measurement of stray load loss 2) Assumed value of stray load loss—load point calibrated	Summation of losses (Calibrated driving machine)
Equivalent circuit 1) Direct measurement of stray load loss—loads point calibrated 2) Assumed value of stray load loss—load point calibrated	—
—	Electrical back-to-back

TABLE 3. INSTRUMENT ACCURACY

	IEEE 112-1996	IEC 60034-2
General	±0.2%	±0.5%
Three-phase wattmeter	±0.2%	±1.0%
Transformers	±0.2%	Included
Speed/slip	Stroboscope/ digital	Stroboscope/ digital
Torque		
a) Rating	≤15%	—
b) Sensitivity	±0.25%	—
EPACT (IEEE 112-1996)		
General	±0.2%	—
Transformers	±0.2%	—
Combined	±0.2%	—
Speed	±1 rpm	—
Torque	±0.2%	—

General differences between IEEE 112B and IEC 60034-2

- IEC does not require bearing temperature stabilization for determining core loss and friction and windage (F&W) loss from no-load test. IEEE requires successive read-

ings of 3% or less in half-hour intervals.

- For load testing, IEC uses tested temperature for I²R loss of the stator. IEEE uses tested temperature rise plus 25° C.
- For load testing, IEC does not specify any temperature correction for slip (rotor I²R loss). IEEE corrects to specified stator temperature.
- For temperature correction of copper windings, IEC uses 234.5 degrees C. IEEE proposes to use 235° C.

TABLE 4. REFERENCE TEMPERATURE

	IEEE 112-1996	IEC 60034-2
Ambient	25° C	20° C
Specified		
1) Test	Preferred	Used only for load test
2) Other		
Class A/E	75° C	75° C
Class B	95° C	95° C
Class F	115° C	115° C
Class H	130° C	130° C

Stray load loss (SLL). Except for load tests (braking, back-to-back, and calibrated machine), IEC uses a specified percentage for SLL. The specified value is 0.5% of input at rated load, which is assumed to vary as the square of the stator current at other loads.

For all load tests except input-output, IEEE requires determination of the SLL by indirect measurement with data smoothing—i.e., raw SLL is the total loss minus remaining segregated (and measurable) losses.

For non-load tests, IEEE requires direct measurement of SLL unless otherwise agreed upon. Table 5 shows the assumed value at rated load. Values of SLL at other loads are assumed to vary as the square of the rotor current.

TABLE 5. IEEE 112 ASSUMED STRAY LOAD LOSS VS. HP/KW

Machine rating	Stray load loss % of rated output
1 - 125 hp / 0.75 - 93 kW	1.8%
126 - 500 hp / 94 - 373 kW	1.5%
501 - 2499 hp / 374 - 1864 kW	1.2%
2500 hp / 1865 kW and larger	0.9%

Input - output tests: IEEE 112-1996 vs. IEC 60034-2

- IEC does not specify any limitations on dynamometer size or sensitivity.
- IEC does not specify dynamometer correction for friction and windage.
- IEC uses tested temperature rise without correction. IEEE uses tested temperature rise plus 25° C.

- IEEE specifies 6 load points. IEC does not specify any load points.

Input - output tests with loss segregation (indirect measurement of stray load loss): IEEE 112-1996 vs. IEC 60034-2

IEC has no equivalent test method.

Electrical power measurement with loss segregation: IEEE 112-1996 vs. IEC 60034-2

- IEEE requires actual measurement of SLL by reverse rotation test. Specified value accepted only by agreement. IEC uses a conservative specified value.
- IEEE requires actual loading of the machine at 6 load points. IEC does not specify the number of load points and allows the use of reduced voltage loading at constant slip and with vector correction of the stator current to determine load losses.
- Both IEEE and IEC correct stator I^2R losses to the same specified temperature. However, IEC makes no temperature correction for rotor I^2R losses.

Miscellaneous information: NEMA MG 1-1998, Rev. 3 vs. IEC 60034-1-1998

- IEC does not use service factors.
- IEC allows less power supply variations.
- Temperature rise limits are generally the same.
- Torque characteristics are very similar.
- IEC inrush current requirements are not as tight as NEMA's and generally allow 20% or greater on 5 hp (3.5 kW) and larger.
- IEC does not assign a specific output rating to a frame, but does specify preferred outputs.

TABLE 6. TOLERANCES

	IEEE 112-1996	IEC60034-1-1998
Summation of losses	See note.	≤50 kW -15% of (1 - eff.)
	See note.	>50 kW -10% of (1 - eff.)
Input/output	See note.	-15% of (1 - eff.)
Total losses	See note.	>50 kW +10% of (1 - eff.)

Note: Although IEEE does not specify any tolerance, NEMA and EPACT require that the minimum efficiency of 1 - 500 hp polyphase motors not exceed plus 20% increase in loss from the nominal value.

Table 7 compares the results of IEEE and IEC efficiency testing of the motors in the EASA/AEMT study. The figures represent the efficiency of each motor before rewind.

LOSS SEGREGATION METHOD USED IN EASA/AEMT REWIND STUDY

The EASA/AEMT rewind study used the IEEE 112-1996 method to segregate losses. Applicable sections of the standard are summarized below to help explain the pro-

TABLE 7. IEEE AND IEC EFFICIENCY COMPARISON FOR EASA/AEMT STUDY

Motor	IEEE Efficiency	IEC Efficiency	Difference
1A	94.1	94.7	0.6
2B	92.9	93.5	0.6
3C	94.5	95.3	0.8
4D	95.0	95.0	0.0
5E	92.3	92.3	0.0
6F	94.4	94.4	0.0
7B	93.7	94.0	0.3
8C	96.2	96.3	0.1
9E	90.1	90.3	0.2
10D	95.4	95.3	-0.1
11F	96.4	95.9	-0.5
12F	95.9	95.5	-0.4
13G	94.8	95.3	0.5
14H	89.9	91.2	1.3
15J	93.0	94.2	1.2
16H	95.4	95.5	0.1
17H	86.7	87.3	0.6
18G	94.2	94.2	0.0
19H	93.0	92.7	-0.3
20H	93.9	94.1	0.2
21J	93.7	94.6	0.9
22H	83.2	84.0	0.8
23K	95.7	95.7	0.0
24E	95.1	95.1	0.0

cess. The actual test procedures for determining these losses are described in the standard. Discussion of how instrumentation, dynamometer calibration, methods of temperature correction and numerous other procedural items can affect the accuracy of the acquired data is beyond the scope of this section.

Similar relevant testing standards include Canadian Standard C390, Australian/New Zealand Standard AS/NZS 1359.5, Japanese Standard JEC 2137-2000, and the recently adopted IEC 61972. As explained on Page 1-12, the test standard currently used in Europe (IEC 60034-2) differs from these standards.

Several key issues need to be emphasized in regard to procedure. First, the EASA/AEMT study confirmed that the friction loss does not stabilize until the grease cavity has been adequately purged, which may take considerable time. The study also suggests that in some cases a break-in heat run may affect other losses.

The test protocol employed for this project included a break-in heat run for each unit. Once this was done, care was taken not to alter the grease fill during disassembly, except on motors 1A and 3C, where grease was added.

Determination of efficiency

Efficiency is the ratio of output power to total input power. Output power equals input power minus the losses. There-

fore, if two of the three variables (output, input, or losses) are known, the efficiency can be determined by one of the following equations:

$$\text{efficiency} = \frac{\text{output power}}{\text{input power}}$$

$$\text{efficiency} = \frac{\text{input power} - \text{losses}}{\text{input power}}$$

Test method 112 B: input - output with loss segregation

This method consists of several steps. All data is taken with the machine operating either as a motor or as a generator, depending upon the region of operation for which the efficiency data is required. The apparent total loss (input minus output) is segregated into its various components, with stray load loss defined as the difference between the apparent total loss and the sum of the conventional losses (stator and rotor I²R loss, core loss, and friction and windage loss). The calculated value of stray load loss is plotted vs. torque squared, and a linear regression is used to reduce the effect of random errors in the test measurements. The smoothed stray load loss data is used to calculate the final value of total loss and the efficiency.

Types of losses

Stator I²R loss. The stator I²R loss (in watts) equals 1.5 x I²R for three-phase machines, where:

I = the measured or calculated rms current per line terminal at the specified load

R = the DC resistance between any two line terminals corrected to the specified temperature

Rotor I²R loss. The rotor I²R loss should be determined from the per unit slip, whenever the slip can be determined accurately, using the following equation:

$$\text{Rotor I}^2\text{R loss} = (\text{measured stator input power} - \text{stator I}^2\text{R loss} - \text{core loss}) \cdot \text{slip}$$

Core loss and friction and windage loss (no-load test). The test is made by running the machine as a motor, at rated voltage and frequency without connected load. To ensure that the correct value of friction loss is obtained, the machine should be operated until the input has stabilized.

No-load current. The current in each line is read. The average of the line currents is the no-load current.

No-load losses. The reading of input power is the total of the losses in the motor at no-load. Subtracting the stator I²R loss (at the temperature of this test) from the input gives the sum of the friction (including brush-friction loss on wound-rotor motors), windage, and core losses.

Separation of core loss from friction and windage loss. Separation of the core loss from the friction and windage loss may be made by reading voltage, current, and power input at rated frequency and at voltages ranging from 125% of rated voltage down to the point where further voltage reduction increases the current.

Friction and windage. Power input minus the stator I²R loss is plotted vs. voltage, and the curve so obtained is extended to zero voltage. The intercept with the zero

voltage axis is the friction and windage loss. The intercept may be determined more accurately if the input minus stator I²R loss is plotted against the voltage squared for values in the lower voltage range.

Core loss. The core loss at no load and rated voltage is obtained by subtracting the value of friction and windage loss from the sum of the friction, windage, and core loss.

Stray-load loss. The stray load loss is that portion of the total loss in a machine not accounted for by the sum of friction and windage, stator I²R loss, rotor I²R loss, and core loss.

Indirect measurement of stray load loss. The stray load loss is determined by measuring the total losses, and subtracting from these losses the sum of the friction and windage, core loss, stator I²R loss, and rotor I²R loss.

Stray load loss cannot be measured directly since it has many sources and their relative contribution will change between machines of different design and manufacture. In IEEE 112B, residual loss is evaluated by subtracting the measured output power of the motor from the input power less all of the other losses.

Residual loss will equal stray load loss if there is no measurement error. Since two large quantities of almost equal value are being subtracted to yield a very small quantity, a high degree of measurement accuracy is required. The biggest error, however, can come from the need for an accurate measurement of torque (of the order of 0.1% error or better) to evaluate output power precisely.

The determination of true zero torque is always a problem. The IEEE standard suggests comparing input and output powers at very light load, where most of the motor losses are due to windage and friction, the stator winding, and the machine core. Here stray load loss can be assumed to be insignificant. The torque reading can be adjusted under this condition so that input power less known losses equals output power.

Impact of too much bearing grease

A number of studies have found that over-greasing the bearings can increase friction losses (see Part 2: *Good Practice Guide To Maintain Motor Efficiency* for more information). For the EASA/AEMT rewind study, grease was added to the bearings of two rewound test units in Group A.

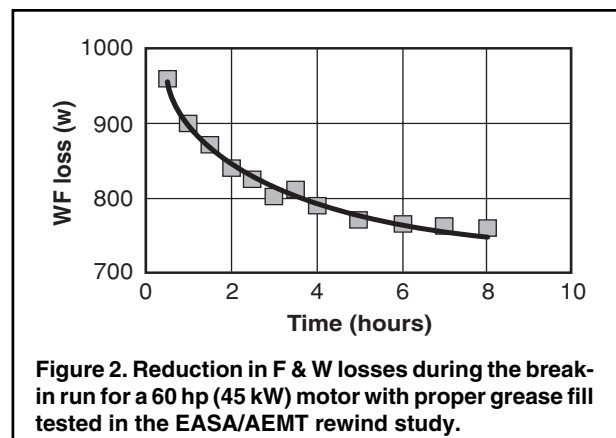

No change in lubrication was made on the rest of the motors in the test. As expected, bearing friction on the regreased motors increased and efficiency dropped 0.3 to 0.5 percent. Figure 2 illustrates the decrease in losses over time for a properly lubricated 60 hp (45 kW) motor in the EASA/AEMT study.

Stray loss analysis

The stray load losses for the motors in Group A of the EASA/AEMT rewind study increased significantly. The cause was the mechanical damage done to the stator core (i.e., flared ends of lamination teeth) in removing the old windings and slot insulation. This, in turn, increased the pulsating or zig-zag losses (see Part 2: *Good Practice Guide To Maintain Motor Efficiency* for more information).

The burnout temperature for the motors in Group A was 660° F (350° C)—too low to completely break down the old winding insulation. As a result, it took excessive force and extra cleaning to strip out the old windings. The resulting mechanical damage increased stray load losses.

The burnout temperature for motors in Groups B, C and D of the study was increased to 680 - 700° F (360 - 370° C). This broke down the old insulation more completely, making it easier to remove the windings and clean the slots. Since lamination teeth were not damaged in the process, the stray load losses did not increase.

CORE LOSS TESTING

One objective of the EASA/AEMT rewind study was to evaluate the correlation between the actual stator core loss as tested in accordance with IEEE 112B and the various test methods that service centers use to determine the condition of the stator core before and after the windings have been removed. The test methods evaluated were the conventional loop test and two commercial devices from different manufacturers.

IEEE 112B core loss test. The stator core loss is determined in the IEEE 112B test by operating the motor at rated voltage and frequency without connected load. To ensure that the correct value of friction loss is obtained, measurements should not be taken until the input has stabilized. The first measurement is the no-load current. The current in each line is read and the average of the line currents is taken to be the no-load current. Next, the no-load losses are determined by measuring the total input power at no load. Subtracting the stator winding I²R loss (at the temperature of the test) from the input power gives the sum of the friction, windage, and core losses.

Separation of the core loss from the friction and windage loss is accomplished by reading the voltage, current, and power input at rated frequency and at voltages ranging from 125% of rated voltage down to the point where further voltage reduction increases the no-load current. The power input minus the stator I²R loss is plotted versus voltage, and the resulting curve is extended to zero voltage. The intercept with the zero voltage axis provides the value of the friction and windage loss. The intercept may be determined more accurately if the input minus stator I²R loss is plotted against the voltage squared for values in the lower voltage

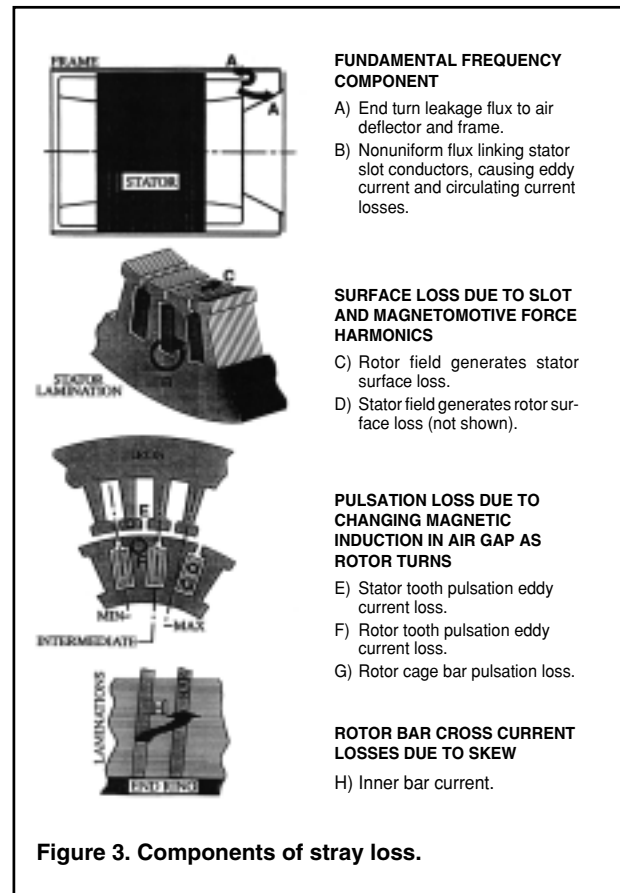

Figure 3. Components of stray loss.

range. The core loss at no load and rated voltage is obtained by subtracting the value of friction and windage loss from the sum of the friction, windage, and core loss.

Loop test. The loop test (also called the ring test) is a core testing technique primarily intended to detect hot spots (i.e., localized areas where interlaminar insulation is damaged) in a stator core. Calculations of the number of loop turns required for a desired core magnetizing flux level are made with a target flux level of 85,000 lines per square inch (85 kl/in² or 1.32 Tesla) being common. Some service centers calculate the loop turns required to magnetize the stator core to the core flux level of the winding design, calling this a “full flux” core test. The distribution of the flux induced in the core by the loop test, however, is not the same as that

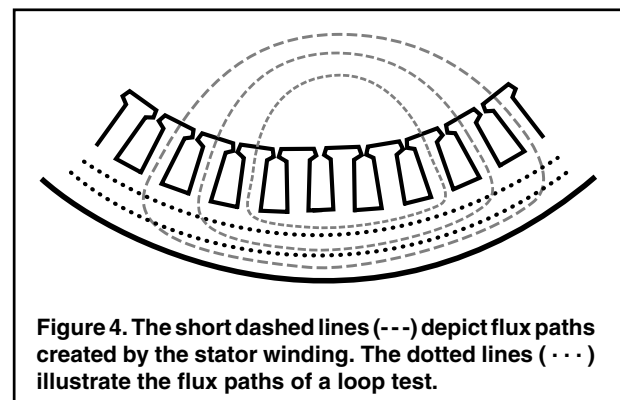

Figure 4. The short dashed lines (---) depict flux paths created by the stator winding. The dotted lines (···) illustrate the flux paths of a loop test.

induced by the machine's winding, particularly when the rotor is removed (see Figure 4).

The loop test is set up by inserting and wrapping turns of lead wire around the core—i.e., passing the leads through the stator bore and around the exterior of the core or stator frame. The core magnetization calculations provide an ampere-turn value that will excite the core to the desired magnetic flux level. For example, if 3600 ampere-turns were required for a magnetization level of 85 kI/in² (1.32T), and it was desired to limit the current through the loop turn lead wire to 80 amperes, then the loop turns required would be 45 (80 x 45 = 3600). The loop turns are typically wrapped in close proximity to each other, so as to maximize the area of the core that can be probed for hot spots.

A complete test of the core may require repeating the loop test with the loop turns placed in a different location to expose the area that was made inaccessible by the initial location of the loop test turns. The core can be probed for hot spots with an infrared thermal detector or thermocouples.

In terms of EASA/AEMT rewind study, the loop test was used to compare the core loss watts before and after winding removal. The measurement was made by inserting a one-turn search coil to detect voltage induced in the core and a true-RMS current transformer to detect the amperage in the loop turns. The voltage and current were then sensed by a wattmeter. The test was performed at the same level of magnetization for both the before winding removal and after winding removal loop tests.

Commercial core testers. Commercial core testers perform core tests that are equivalent in flux pattern to the loop test. The advantages of using the commercial testers over the conventional loop test are primarily to save time in performing the test and to improve the repeatability of test results. Commercial testers normally require only a single loop turn, because they can produce large amounts of current. Further, the testers usually have built-in metering to display current and power. Computer programs typically available from the tester manufacturers can calculate the value of current required to achieve a desired level of magnetic flux, as well as the actual flux level attained during the test. The core can be probed for hot spots, just as with the conventional loop test. Since the magnetic flux path is the same as that of the loop test, the core loss value indicated by the commercial device core test is not comparable to the core loss determined by IEEE 112B.

Core test acceptance levels. Most manufacturers of commercial core testers (including the two whose machines were used in the EASA/AEMT rewind study) suggest a test flux level of 85 kI/in² (1.32T) in the core back iron. A potential drawback to this approach is that the core material may be approaching the “knee” of the magnetic strength versus current curve—i.e., saturation. That being the case, a large increase in current might not result in a meaningful increase in magnetic flux, because the curve is just that, a curve, not a straight line. Since this condition can distort the results of a before and after core test, it is suggested that the tolerance on core loss after winding removal should be 20%. That is, the core loss value after winding removal, whether measured by conventional loop test or commercial tester, should not exceed that of the before test by more than 20%. To

isolate a hot spot in the core, a higher flux level [from 85 kI/in² (1.32T) up to 97 kI/in² (1.5T)] is recommended.

Due to the wide variety of electrical magnetic steels used by motor manufacturers, it is impossible to set rigid rules for core test acceptance in terms of watts loss per pound. The criteria are greatly affected by the permeability of each type of steel. The EASA/AEMT study confirmed, however, that testing the core with the loop test or a commercial tester before and after winding removal can detect increased losses caused by burning out and cleaning the core.

Comparison of Results for Different Core Loss Test Methods. As part of the EASA/AEMT rewind study, core tests were performed on each motor in accordance with IEEE 112B before and after the core was stripped and cleaned. The loop test was performed on almost every core, again before and after winding removal. Motors representative of the various sizes in the study were also tested before and after winding removal using the commercial core testers. Not all cores were tested with the commercial devices, however, due to the availability of the test machines.

The results of the loop test and commercial core testers were compared with the changes in losses measured by the IEEE 112B method for tests performed before and after winding removal. This evaluation was inconclusive, however, because:

- The results from the three test methods varied significantly.
- In some cases the test data showed a drop in core loss after coil removal.
- Some difficulty was experienced in operating the commercial testers; this may have contributed to the erratic results.
- Evaluation of the test results indicated that the sample size was too small to draw any accurate conclusion.

Although the test results did not correlate well for the different test methods, it was apparent that core testing does produce repeatable and valid indications of core degradation or preservation. Therefore each of the methods can be useful in assessing the condition of the core before and after burnout.

TEST DATA FOR EASA/AEMT STUDY

The 24 new motors studied were divided into four groups to accommodate the different test variables. The test results summarized below show no significant change in the efficiency of motors rewound using good practice repair procedures (within the range of accuracy of the IEEE 112B test method), and that in several cases efficiency actually increased. The complete test data for the motors in the EASA/AEMT rewind study are provided in Tables 8 - 13.

Group A Six low-voltage motors [100 - 150 hp (75 - 112 kW) rewound once. No specific controls on stripping and rewind processes with burnout temperature of 660° F (350° C).

Results: Initially showed **average efficiency change of -0.6% after 1 rewind (range -0.3 to -1.0%)**.

However, two motors that showed the greatest efficiency reduction had been relubricated during assembly, which increased the friction loss.

After this was corrected the **average efficiency change was -0.4% (range -0.3 to -0.5%)**.

Group B Ten low-voltage motors [60 - 200 hp (45 - 150 kW)] rewind once. Controlled stripping and rewind processes with burnout temperature of 680° F - 700° F (360° C - 370° C).

Results: Average efficiency change of -0.1% (range +0.2 to -0.7%).

One motor was subsequently found to have faulty interlaminar insulation as supplied. Omitting the result from this motor, the **average efficiency change was -0.03% (range +0.2 to -0.2%)**.

Group C Low-voltage motors rewind more than once. Controlled stripping and rewind processes.

Group C1. Five low-voltage motors [100 - 200 hp (75 - 150 kW)] rewind two or three times. Controlled stripping and rewind processes with burnout temperature of 680° F - 700° F (360° C - 370° C).

Results: Average efficiency change of -0.1% (range +0.6 to -0.4%) after 3 rewinds (3 machines) and 2 rewinds (2 machines).

Group C2. Two low-voltage motors [7.5 hp (5.5 kW)] processed in burnout over three times and rewind once. Controlled stripping and rewind processes with burnout temperature of 680° F - 700° F (360° C - 370° C).

Results: Average efficiency change of +0.5% (range +0.2 to +0.8%).

Group D One medium-voltage motor [300 hp (225 kW/ 3.3 kV)] with formed stator coils rewind once. Controlled stripping and rewind processes with burnout temperature of 680° F - 700° F (360° C - 370° C).

Results: Efficiency change of -0.2%. The behavior of this motor was similar to the low-voltage machines rewind with specific controls.

Tables 9 to 12 show the full-load performance figures for each group calculated in accordance with IEEE 112B. Each motor is identified by a code number (far left column). In some cases, more than one motor was made by the same manufacturer.

Each motor was initially tested and then dismantled, stripped of its stator windings, rewind, reassembled and retested. To minimize performance changes due to factors

other than normal rewind procedures, rotor assemblies were not changed. In the case of 1A and 3C, the bearings were relubricated. This violated the test protocol but showed that overlubrication significantly increased friction and windage losses and decreased efficiency.

To stabilize the losses, a break-in heat run was performed prior to testing. The method of data collection was all computerized and recorded on IEEE112-1996 Form B.

Also included in this section are the results of the round robin testing of a single motor, as well as a sample file of test data in accordance with IEEE 112B.

Significance of Tests Results

The test results for each controlled group falls within the range of the deviation of the round robin tests, indicating that test procedures were in accordance with approved industry practice (see side-bar on "Round Robin Testing").

The average efficiency change for each controlled group also falls within the range of accuracy for the test method ($\pm 0.2\%$), showing that motors repaired/rewound following good practices maintained their original efficiency, and that in several instances efficiency actually improved.

All motors were burned out at controlled temperatures. Other specific controls applied to motors (except those in Group A) included control of core cleaning methods and rewind details such as turns/coil, mean length of turn, and conductor cross sectional area. The benefits of these controls form the basis of the *Good Practice Guide to Maintain Motor Efficiency* (Part 2).

TABLE 8. COMPARISON OF LOSS DISTRIBUTION BY PERCENT FOR MOTORS TESTED IN THE EASA/AEMT STUDY

Losses	2 pole average	4 pole average	Design factors affecting losses
Core losses (W_c)	19%	21%	Electrical steel, air gap, saturation, supply frequency, condition of interlaminar insulation
Friction and windage losses (W_{fw})	25%	10%	Fan efficiency, lubrication, bearings, seals
Stator I^2R losses (W_s)	26%	34%	Conductor area, mean length of turn, heat dissipation
Rotor I^2R losses (W_r)	19%	21%	Bar and end ring area and material
Stray load losses (W_l)	11%	14%	Manufacturing processes, slot design, air gap, condition of air gap surfaces and end laminations

TABLE 9. GROUP A—LOW-VOLTAGE MOTORS REWOUND WITH NO SPECIFIC CONTROL ON STRIPPING OR REWIND

Motor	Test	Winding resistance (ohms)	Temp (° C)	Corr. resistance (ohms)	% load	Stator loss (watts)	Rotor loss (watts)	Core loss (watts)	Windage & friction (watts)	Stray loss (watts)	Efficiency (%)	Change (%)	Notes
1A 100 hp, 2 pole	before	0.0580	45.00	0.0538	102.5	1458.1	834.0	1163.8	526.0	805.0	94.1		
	after	0.0591	45.45	0.0548	99.9	1313.1	773.9	1298.7	1152.0	977.3	93.1	-1.0	
	after	0.0601	47.85	0.0552	100.1	1323.1	774.2	1251.5	993.5	976.9	93.3	-0.8	DE bearing cleaned
	after	0.0601	47.85	0.0552	99.9	1323.1	770.9	1257.3	857	969.6	93.5	-0.6	Both bearings cleaned
	after	0.0601	47.85	0.0552	100.0	1323.1	770.5	1298.7	755.5	959.3	93.6	-0.5	Bearings replaced
2B 100 hp, 4 pole	before	0.0933	37.10	0.0892	102.3	2640.8	1608.5	499.7	386.0	655.5	92.9		
	after	0.0927	34.08	0.0896	99.9	2536.6	1661.2	526.3	360.6	1043.4	92.4	-0.5	
3C 100 hp, 2 pole	before	0.0448	36.70	0.0429	100.4	1423.2	714.0	632.8	609.8	944.1	94.5		
	after	0.0496	54.00	0.0446	99.5	1560.5	726.0	659.6	1151.1	1076.1	93.5	-1.0	
	after	0.0484	41.47	0.0455	99.5	1591.7	722.2	656.3	730.8	1047.3	94.0	-0.5	DE bearing cleaned
	after	0.0484	41.47	0.0455	99.0	1590.3	718.1	656.8	679.6	1050.1	94.1	-0.5	Both bearings cleaned
4D 100 hp, 2 pole	before	0.0385	38.90	0.0366	99.2	852.0	752.4	705.4	1161.4	440.6	95.0		
	after	0.0415	36.93	0.0397	100.2	930.7	774.7	752.0	1137.4	719.0	94.5	-0.5	
5E 150 hp, 2 pole	before	0.0611	32.90	0.0593	100.5	3436.2	1593.2	1906.9	1689.7	715.7	92.3		
	after	0.0652	34.65	0.0628	99.7	3486.2	1621.5	2300.1	1639.8	717.5	92.0	-0.3	
7B 150 hp, 2 pole	before	0.0268	49.70	0.0245	99.8	1247.6	1381.6	1179.2	2781.6	942.1	93.7		
	after	0.0268	43.90	0.0250	99.9	1255.2	1439.9	1256.0	3077.0	1051.1	93.3	-0.4	

TABLE 10. GROUP B-LOW-VOLTAGE MOTORS REWOUND ONCE WITH CONTROLLED REWIND PROCESS

Motor	Test	Winding resistance (ohms)	Temp (° C)	Corr. resistance (ohms)	% load	Stator loss (watts)	Rotor loss (watts)	Core loss (watts)	Windage & friction	Stray loss (watts)	Efficiency (%)	Change (%)	Notes
6F 150 hp, 2 pole	before	0.0359	31.60	0.0350	100.4	1661.9	1637.1	988.5	1586.4	743.0	94.4		
	after	0.0390	30.63	0.0382	99.8	1729.8	1624.2	1058.2	1624.8	662.5	94.3	-0.1	
9E 60 hp, 2 pole	before	0.1308	45.57	0.1212	99.8	1055.4	1124.2	647.7	1674.7	392.5	90.1		
	after	0.1266	43.17	0.1183	100.1	1026.0	1206.0	679.8	1645.0	497.8	89.9	-0.2	
10D 125 hp, 4 pole	before	0.0347	28.95	0.0341	100.0	1317.9	931.1	785.3	986.8	602.1	95.4		
	after	0.0360	36.67	0.0344	100.1	1286.9	964.3	847.5	936.4	750.6	95.2	-0.2	
11F 200 hp, 2 pole	before	0.0203	50.48	0.0185	99.8	1721.1	1020.7	1333.3	1439.7	113.8	96.4		
	after	0.0208	47.47	0.0192	100.1	1799.3	1250.9	1291.6	1291.1	114.3	96.3	-0.1	
14H 50 Hz 55 kW, 4 pole,	before	0.0675	47.42	0.0621	100.0	1577.0	1215.7	1650.2	664.9	1069.7	89.9		
	after	0.0600	47.30	0.0553	99.9	1405.2	1165.3	2447.6	750.7	882.7	89.2	-0.7	Faulty core iron
16H 50 Hz 150 kW, 4 pole	before	0.0196	45.75	0.0182	99.0	2304.3	1053.0	2122.9	740.1	904.8	95.4		
	after	0.0171	36.85	0.0163	100.1	1981.1	1017.6	2075.1	772.9	1112.0	95.6	+0.2	
18G 50 Hz 55 kW, 4 pole	before	0.0775	48.70	0.0711	99.2	1334.6	803.1	733.2	219.6	277.6	94.2		
	after	0.0710	34.75	0.0685	100.0	1310.9	824.6	737.5	229.3	303.3	94.2	0	
19H 50 Hz 132 kW, 2 pole	before	0.0296	43.97	0.0276	99.6	2537.6	1704.8	1925.3	3434.0	475.1	93.0		
	after	0.0259	36.15	0.0248	99.7	2167.1	1684.8	1863.0	3722.7	403.9	93.0	0	
20H 50 Hz 45 kW, 2 pole	before	0.0773	41.53	0.0727	101.0	801.8	697.0	722.1	386.4	363.1	93.9		
	after	0.0712	39.03	0.0676	100.3	707.9	669.6	664.1	451.2	427.3	93.9	0	
21J 50 Hz 75 kW, 2 pole	before	0.0468	44.55	0.0435	99.6	1319.6	870.0	1146.0	566.2	1087.9	93.7		
	after	0.0435	40.38	0.0411	99.9	1239.9	856.7	1126.8	510.4	1093.2	93.9	+0.2	
24E 100 hp, 4 pole	before	0.0951	39.58	0.0900	100.4	1389.4	759.4	876.9	389.2	415.7	95.1		
	after	0.0936	34.99	0.0902	100.0	1465.7	775.3	1032.6	420.0	274.5	95.0	-0.1	

TABLE 11. GROUP C-LOW-VOLTAGE MOTORS REWOUND MORE THAN ONCE WITH CONTROLLED PROCESSES

Motor	Test	Winding resistance (ohms)	Temp (° C)	Corr. resistance (ohms)	% load	Stator loss (watts)	Rotor loss (watts)	Core loss (watts)	Windage & friction (watts)	Stray loss (watts)	Efficiency (%)	Change (%)	Notes
4D 100 hp, 2 pole	before	0.0385	38.9	0.0366	99.2	852.0	752.4	705.4	1161.4	440.6	95.0		
	after	0.0415	36.93	0.0397	100.2	930.7	774.7	752.0	1137.4	719.0	94.5	-0.5	1st rewind
	after	0.4083	36.13	0.0391	100.2	895.1	745	686.2	1159.9	562.2	94.9	-0.1	2nd rewind
	after	0.4087	37.78	0.0389	100.5	896.4	744.9	693.0	1140.7	596.2	94.8	-0.2	3rd rewind
12F 150 hp, 2 pole	before	0.0276	51.32	0.0250	99.9	1326.8	795.7	1123.0	1394.8	163.2	95.9		
	after	0.0272	50.33	0.0248	100.0	1280.2	852.8	1108.8	1296.7	282.1	95.9	0.0	1st rewind
15J 50 Hz 75 kW, 4 pole	after	0.0259	43.43	0.0241	100.0	1243.1	830.9	1050.0	1307.2	380.1	95.9	0.0	2nd rewind
	after	0.0266	43.52	0.0248	100.1	1295.6	817.2	1093.6	1427.8	216.4	95.8	-0.1	3rd rewind
	before	0.0465	43.37	0.0435	100.3	1805.3	1204.2	1093.7	319.7	1280.7	93.0		
	after	0.0404	34.92	0.0389	100.2	1546.0	1102.9	1078.3	272.4	1117.3	93.6	+0.6	1st rewind
8C 200 hp, 4 pole	after	0.0402	34.6	0.0387	100.2	1523.1	1098.0	1078.7	309.3	1138.6	93.6	0.0	2nd rewind
	after	0.0397	33.35	0.0385	100.3	1489.3	1059.7	1131.9	297.6	1094.6	93.7	0.1	3rd rewind
	before	0.0217	43.73	0.0202	99.2	1922.6	1129.1	1459.6	448.1	851.0	96.2		Fan blade broken ¹
	after	0.0194	38.33	0.0185	99.1	1775.5	1238.4	1612.1	358.2	1632.4	95.7	-0.5	Winding pattern changed
13G 50 Hz 110 kW, 4 pole	before	0.0217	43.73	0.0202	99.0	1922.6	1129.1	1459.6	761.3	851.0	96.0	-0.2	Effect of new fan fitted
	after	0.0199	30.68	0.0195	99.8	1772.1	1121.0	1618.8	671.4	1621.3	95.6	-0.4	2nd rewind, new fan
	before	0.0228	29.0	0.0224	99.4	1647.6	915.9	1453.9	856.9	1087.3	94.8		
	after	0.0236	39.37	0.0224	99.9	1662.7	932.0	1576.3	912.6	1250	94.6	-0.2	1st rewind
17H 50 Hz 5.5 kW, 4 pole	after	0.0248	41.82	0.0233	99.9	1702.2	897.6	1388.9	1008.3	1217.4	94.6	0	2nd rewind
	before	1.8100	39.28	1.7156	100.5	411.2	212.9	131.5	22.5	72.8	86.7		
22H 50 Hz 5.5 kW, 4 pole	after	1.6324	36.13	1.5653	99.1	365.6	177.9	153.5	69.2	53.7	86.9	+0.2	
	before	2.1991	42.83	2.0577	99.1	578.1	229.1	196.6	40.6	56.3	83.2		
	after	1.9681	51.15	1.7879	98.9	557.6	194.5	214.0	42.7	25.7	83.6	+0.4	

¹ This value was not used in the final calculations because the motor had a broken fan blade when it was tested. The data was normalized using the friction and windage losses obtained after a new fan was installed.

TABLE 12. GROUP D—MEDIUM-VOLTAGE MOTOR REWOUND ONCE WITH CONTROLLED REWIND PROCESS

Motor	Test	Winding resistance (ohms)	Temp (° C)	Corr. resistance (ohms)	% load	Stator loss (watts)	Rotor loss (watts)	Core loss (watts)	Windage & friction (watts)	Stray loss (watts)	Efficiency (%)	Change (%)	Notes
23K 50 Hz 225 kW, 4 pole 3300V	before	0.6899	34.40	0.6657	99.5	2687.3	2379.8	1928.9	1702.5	1269.4	95.7		See notes below.
	after	0.6766	37.88	0.6446	100.0	2750.3	2561.0	2484.7	855.3	1011.7	95.9	+0.2	See notes below.

Notes for 23K

The friction and windage (F&W) losses were 50% lower on the test after rewinding. This could just have been an error on the separation of core and F&W losses. When the two are added together, the difference is not as significant as 3631.4 before and 3340 after (i.e., a 10% reduction).

This machine was used and had been in storage for some time before testing. It was run at no load before it was sent to Nottingham. The bearing lubrication was not changed during rewinding.

References

- [1] William U. McGovern, "High Efficiency Motors for Upgrading Plant Performance," *Electric Forum* 10, No. 2 (1984), pp. 14-18.
- [2] Roy S. Colby and Denise L. Flora, *Measured Efficiency of High Efficiency and Standard Induction Motors* (North Carolina State University, Department of Electrical and Computer Engineering (IEL), 1990).
- [3] D. H. Dederer, "Rewound Motor Efficiency," *Ontario Hydro Technology Profile* (Ontario Hydro, November 1991).
- [4] Zeller, "Rewound High-Efficiency Motor Performance," *Guides to Energy Management* (BC Hydro, 1992).
- [5] *Rewound Motor Efficiency, TP-91-125* (Ontario Hydro, 1991).
- [6] Advanced Energy, "The Effect of Rewinding on Induction Motor Losses and Efficiency" (EEMODS 02, 2002).

Part 2: *Good Practice Guide To Maintain Motor Efficiency*

Introduction	2-3
Terminology	2-3
Energy Losses in Induction Motors	2-4
Motor Repair Processes	2-10
Preliminary inspection	2-10
Dismantling the motor	2-11
Removing the old winding and cleaning the core	2-14
Rewinding the motor	2-16
Mechanical repairs that can affect motor efficiency	2-20
Reassembling the motor	2-21
Repair Tips	2-21

(This page intentionally left blank.)

Good Practice Guide To Maintain Motor Efficiency

INTRODUCTION

The purpose of this guide is to provide repair/rewind practices and tips that will help service center technicians and motor winders maintain or enhance the efficiency, reliability and quality of the motors they repair.

Realistically, it may not always be possible to achieve these goals, depending on the condition of the motor. In some cases, repair is a “stop gap” action until a suitable replacement can be obtained.

Some of the included procedures derive directly from the EASA/AEMT study of the impact of repair/rewinding on motor efficiency [2003]. Others are based on the findings of an earlier AEMT study of small/medium size three-phase induction motors [1998] and well-established industry good practices.

The procedures in this guide cover all three-phase, random-wound induction motors. Much of the guide also applies to form-wound stators of similar sizes.

(Note: This guide provides many specific procedures and recommendations. Alternative practices may accomplish the same results but must be verified.)

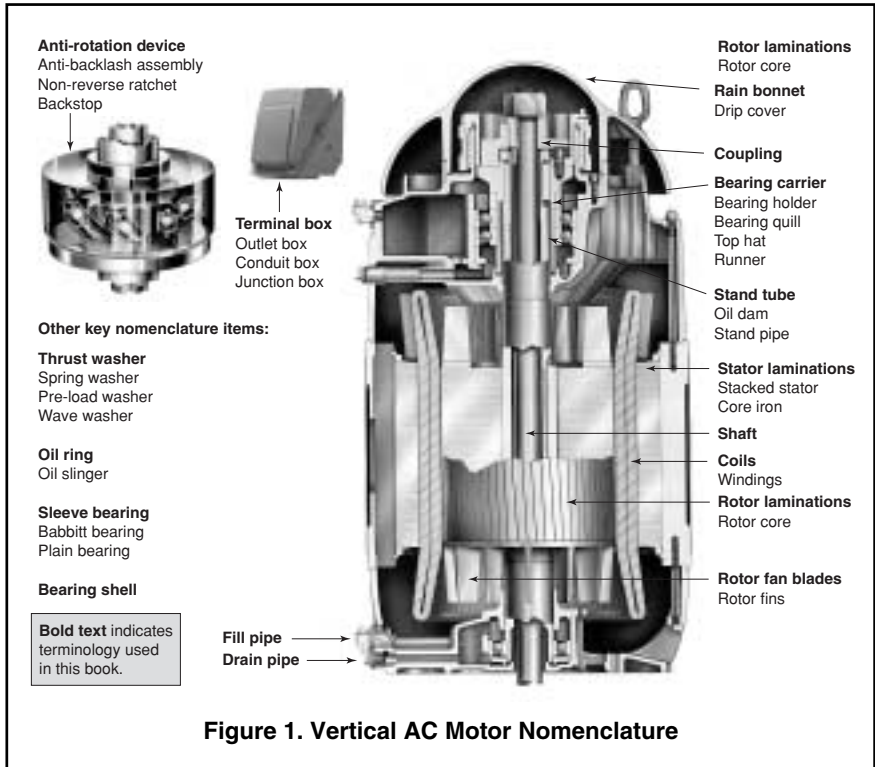

Figure 1. Vertical AC Motor Nomenclature

WARNING Hazardous Area Motors

Some elements of this *Good Practice Guide To Maintain Motor Efficiency*, particularly those concerning changes to windings, are not applicable to hazardous area/explosion-proof motors. Do not use this guide for motors of these types (e.g., UL, CSA, EExd, EExe).

TERMINOLOGY

The terms used to describe horizontal and vertical induction motors in this guide are those commonly found in other EASA, AEMT, NEMA, IEC, IEEE, and ANSI documents. These terms are printed in **bold type** in Figures 1 and 2, with alternate terms listed beneath them.

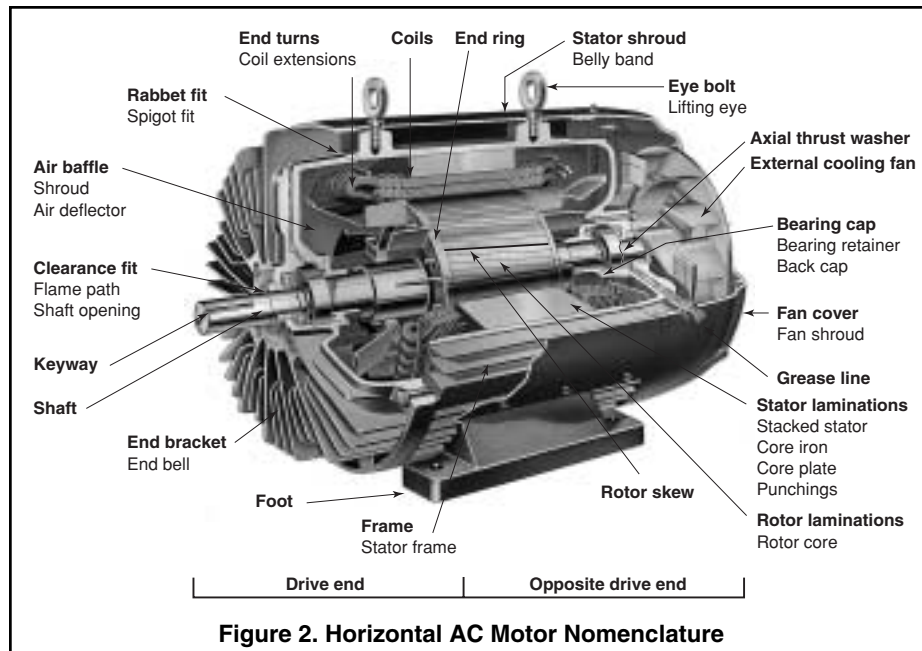

Figure 2. Horizontal AC Motor Nomenclature

ENERGY LOSSES IN INDUCTION MOTORS

There are five types of losses in an induction motor:

- Core losses in the stator and rotor
- Stator I^2R losses
- Rotor I^2R losses
- Friction and windage losses
- Stray load losses

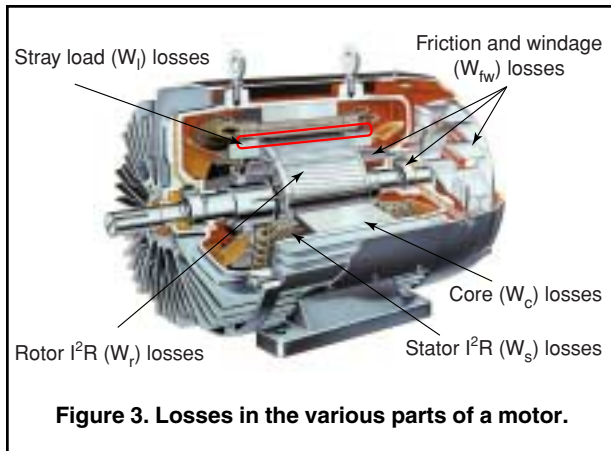

Figure 3. Losses in the various parts of a motor.

The core, friction and windage losses do not significantly change with motor load, provided the motor is operated from a fixed frequency. The I^2R and stray load losses increase significantly as load is increased.

Both core and I^2R losses (and particularly the rotor losses) may be higher when the motor is supplied from a variable-frequency inverter.

In many cases, losses can be decreased during the repair process when good practice procedures are followed.

Figure 4 illustrates how the losses vary in relation to load for a typical 4-pole induction motor.

Table 1 shows a breakdown of the averaged losses for the motors tested in the EASA/AEMT rewind study.

Core (iron) losses

Core losses can increase if excessive pressure is applied to the stator core (e.g., by fitting a new stator frame with too small a bore). Damaging the interlaminar insulation (the very thin layer of insulation between each lamination in the stator and rotor core) can also increase core losses. This can happen if the stator is burned out at too high a temperature (see also *EASA Tech Note 16*).

The following factors affect the quality of the laminations:

- Core and tooth rigidity and ability to hold shape
- Damage caused by the failure
- Quality of the interlaminar insulation (coreplate)
- Damage caused by burnout
- Damage caused by coil removal
- Excessive grinding and filing

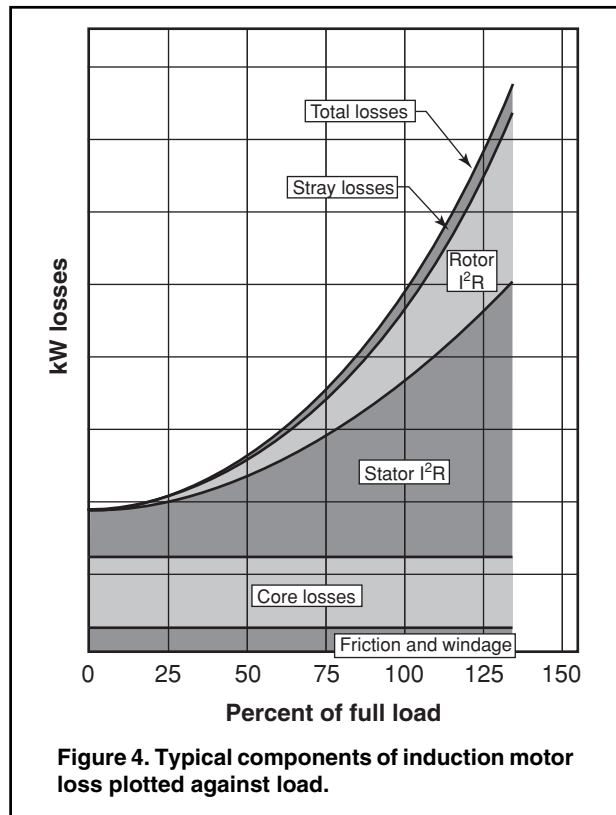

Figure 4. Typical components of induction motor loss plotted against load.

TABLE 1. AVERAGE LOSSES FOR MOTORS TESTED IN THE EASA/AEMT STUDY

Losses	2 pole average	4 pole average	Design factors affecting losses
Core losses (W_c)	19%	21%	Electrical steel, air gap, saturation, supply frequency, condition of interlaminar insulation
Friction and windage losses (W_{fw})	25%	10%	Fan efficiency, lubrication, bearings, seals
Stator I^2R losses (W_s)	26%	34%	Conductor area, mean length of turn, heat dissipation
Rotor I^2R losses (W_r)	19%	21%	Bar and end ring area and material
Stray load losses (W_l)	11%	14%	Manufacturing processes, slot design, air gap, condition of air gap surfaces and end laminations

Burnout process. Tight control of the burnout process is essential. Burning out at a temperature significantly below

680° F (360° C) may not entirely break down the insulation on the old winding. In that case, it will take more force to remove the coils and slot insulation, which may damage to the core (e.g., splayed teeth) and increase the stray load losses.

Burning out at more than 750° F (400° C), however, increases the risk of damaging the interlaminar insulation and may increase the core losses, especially if the interlaminar insulation is organic or otherwise susceptible to high burnout temperatures. Some other lamination insulation processes (e.g., oxide steam-bluing, some waterborne and some organic varnishes) require extreme caution and may not be suitable for burnout.

All satisfactory results in the EASA/AEMT study were achieved with a burnout temperature of 700° F (370° C), with the temperature measured at the tooth area of the stator core.

Loading cautions for burnout ovens. Do not stack stators in the oven; the temperature of the stators on top may be increased by the burning stators underneath. Do not place stators in the oven with the bores vertical; this is especially critical with aluminum frames.

Core losses. Due to the wide variety of electrical magnetic steels in use, it is impossible to set rigid rules for core loss test acceptance. However, measuring core loss before burnout and after core stripping and cleaning will identify significant increases in core losses. If the losses increase by more than 20%, consider replacing the motor. In special cases, consider restacking or replacing the laminations.

Electrical steel considerations. The ability to maintain motor efficiency or to minimize any depreciation in efficiency is influenced by the quality of the stacked stator core and its laminations.

The motor industry uses such a wide variety of electrical steels that it is difficult to generalize their characteristics. The most common considerations include:

- Fully processed vs. semi-processed steel.
- Carbon vs. silicon steel.
- Grain orientation—induction motors use non-oriented electrical steel.
- Hysteresis and eddy current losses ranging from 1.5 to 6 watts/lb (3.3 to 13.2 watts/kg).
- Thickness ranging from .014" to .035" (.4 to .9 mm).
- Interlaminar insulation materials ranging from C-0 to C-5.

Special issues for electrical steels

- Semi-processed steels are usually good candidates for oven burnouts.
- Safe burnout temperature depends on the interlaminar insulation.

Differences among world steel standards complicate this discussion, but the type of the interlaminar insulation is the key issue. When in doubt about the kind of interlaminar insulation a motor has, the safest course is to contact the motor manufacturer.

It also is important to remember that:

- Thin laminations with narrow or unsupported teeth are more susceptible to tooth distortion.
- Laminations with significant damage and hot spots may not be good candidates for rewind, particularly when efficiency is a major consideration.

For more information, see the earlier discussion of "Burn-out process" and Appendix 4: *Electrical Steels*.

Stator I²R Loss

The stator I²R loss is often the largest component of loss. In motors of 45 hp (30 kW) and above tested in the EASA/AEMT rewind study, the average stator I²R loss was 30% of the total loss (range 22 - 46%). Consequently, anything that affects stator I²R loss can have a big impact on the efficiency of a repaired/rewound motor.

Stator I²R loss can be reduced by increasing the conductor cross-sectional area and/or decreasing the mean length of turn (MLT). Changing the winding configuration can also increase the stator I²R loss, although some changes (e.g., increasing the cross-sectional area) will reduce it.

Table 2 contains the results of an earlier EASA study that show the impact on efficiency of a 10% change in end turn length (about a 5% change in MLT) for typical TEFC (IP54) motors. Where it was feasible, reducing the MLT improved the efficiency over the nominal value. From this it is clear that end turn length and MLT are critical to motor efficiency.

Mean length of turn (MLT). Allowing the MLT to increase will increase stator I²R losses and therefore decrease motor efficiency. Conversely, decreasing the MLT where possible will reduce stator I²R losses to help maintain or even improve efficiency. The goal is to reduce the straight section of the coil where it exits the slot to the minimum required to avoid mechanical strain on the slot cell. Whatever coil shape is used, make sure the coil end turns are no longer than those of the original winding.

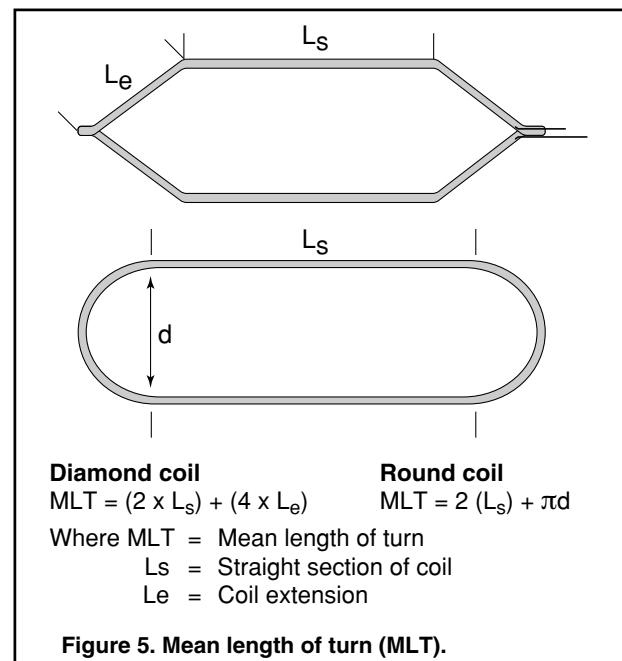

Avoid reducing the MLT too much. Doing so could make the stator difficult or even impossible to wind. It may even affect cooling, in extreme cases causing winding temperature to rise.

Rotor Losses

Rotor losses will increase if flux is reduced as a result of a change to the stator winding or end-ring cross-section. They also can increase due to change/damage to rotor conductors of a squirrel cage motor. Taking a skim cut of the rotor can also affect rotor losses.

Friction and Windage Losses

The friction and windage losses can be increased by:

- Badly fitted bearings, excessive interference fits
- The addition or use of incorrect seals, lack of seal lubrication, or damage to shaft surface (lip seals) or end bracket surface (face seals).
- Installing an incorrect replacement fan.
- Over-greasing the bearings.

It is also important to keep air passages clear—i.e., the ducts and channels in the frame or core through or over which cooling air passes. Wholly or partially blocked ducts or channels may reduce friction and windage loss, but the reduced cooling effect will increase other losses—particularly stator I²R loss—much more. This can lead to early failure as well as reduced operating efficiency.

Impact of too much bearing grease. A number of studies have found that over-greasing the bearings can increase friction losses (see Figures 6, 7 and 8). For the EASA/AEMT rewind study, grease was added to the bearings of two rewound test units in Group A. No change in lubrication was made on the rest of the motors in the test. As expected, bearing friction on the regreased motors increased and efficiency dropped 0.3 to 0.5%. Figure 9 illustrates the decrease in losses over time for one of the 60 hp (45 kW) motors in the EASA/AEMT study.

Stray Losses

Stray load losses are typically 10 - 20% of total motor loss. The high frequency harmonic fluxes that occur near the air gap surfaces of the stator and the rotor core are a major source of stray loss. These are caused by magnetic interaction of the stator and rotor teeth.

Stray loss can increase if the air gap surfaces of the laminations are smeared together (e.g., by mechanical damage, excessive filing or grinding, etc.). Stray loss will also increase if the air gap is uneven (i.e., stator and rotor not concentric) or if the rotor core is axially displaced relative to the stator (e.g., if a wrong replacement rotor is installed).

Stray loss analysis. The stray load losses for the motors in Group A of the EASA/AEMT rewind study increased significantly. The cause was the mechanical damage done to the stator core (i.e., flared ends of lamination teeth) in removing the old windings and slot insulation. This in turn

TABLE 2. EFFECT OF CHANGES TO THE END TURN LENGTH ON TYPICAL TEFC/IP54, 460V DESIGNS

HP/kW	Poles	End turn length	Full load efficiency (%)	Total losses (watts)	Change in total losses (%)
50/37	4	10% short	93.1	2746	-2.8
		Nominal	93.0	2825	
		10% long	92.8	2911	3.0
100/75	4	10% short	94.9	4020	-2.6
		Nominal	94.8	4129	
		10% long	94.6	4243	2.8
200/150	4	10% short	95.6	6921	-2.5
		Nominal	95.5	7099	
		10% long	95.3	7278	2.5
50/37	2	10% short	92.7	2935	-2.9
		Nominal	92.5	3024	
		10% long	92.3	3122	3.2
100/75	2	10% short	93.9	4881	-3.3
		Nominal	93.7	5047	
		10% long	93.5	5212	3.3
200/150	2	10% short	95.1	7697	-2.3
		Nominal	95.0	7875	
		10% long	94.9	8075	2.5

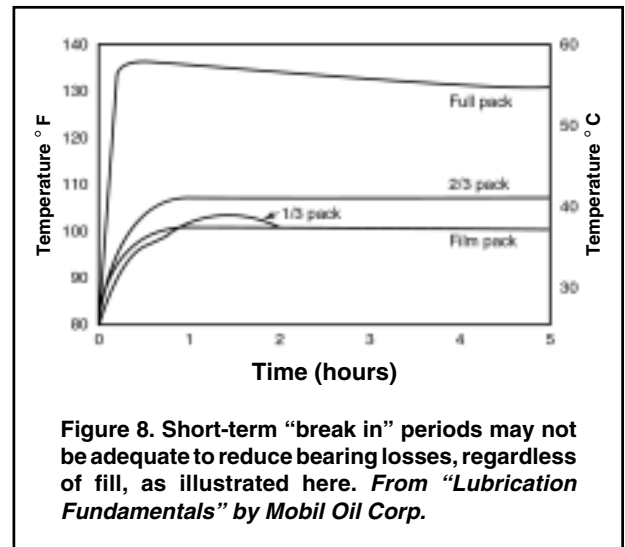
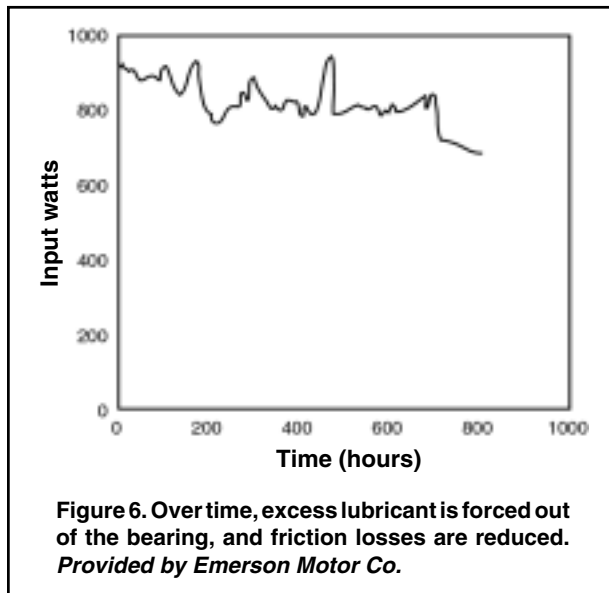

increased the pulsating or zigzag losses (see Figure 10).

The burnout temperature for the motors in Group A was 660° F (350° C) which is too low to completely break down the old winding insulation. As a result, it took excessive force and extra cleaning to strip out the old windings. The resultant mechanical damage increased stray load losses.

The burnout temperature for motors in Groups B, C and D of the study was increased to 680 - 700° F (360 - 370° C). This broke down the old insulation more completely, making it easier to remove the windings and clean the slots. Since lamination teeth were not damaged in the process, the stray load losses did not increase.

Summary of Factors That Can Increase Motor Losses

In comparative tests before and after rewind, the EASA/AEMT study found the biggest changes in core loss and

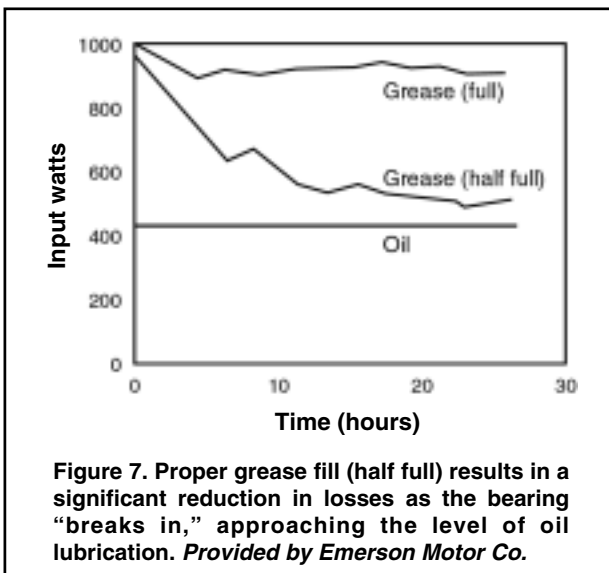
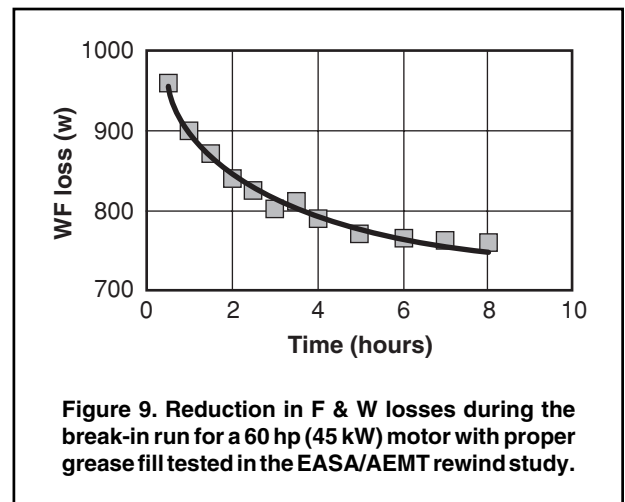

stray load loss. As described above, the change in stray load losses for motors in Group A was caused in part by damage done to the stator teeth in removing coils that had not been completely burned out. (This portion of the stray loss is the pulsation loss due to changing magnetic induction in air gap.)

The burnout oven temperature for Groups B, C, and D was therefore increased from 660° F (350° C) to 680 - 700° F (360 - 370° C). As a result, changes in stray load losses in these groups were significantly reduced.

Listed below are factors that can affect the different energy loss components in induction motors:

Stator core losses

- Flux density change
- Excessive radial or axial pressure on core
- Excessive heating during burnout (i.e., damage to inter-laminar insulation)
- Mechanical damage to core (e.g., splayed lamination teeth, smeared laminations)

Stator I²R losses

- Increased MLT of coils (end turns that are too long)
- Reduced stator conductor cross sectional area
- Some changes to stator winding configuration

Rotor losses

- Change to end ring cross section
- Change/damage to rotor
- Machining the rotor
- Flux density change

Friction and windage losses—changes to

- Bearings
- Seals
- Lubrication
- Fan
- Air passages
- Operating temperature

Stray loss

- Damage to air gap surfaces
- Uneven air gap (i.e., rotor eccentric with respect to stator bore)
- Change in air gap
- Damage to end laminations

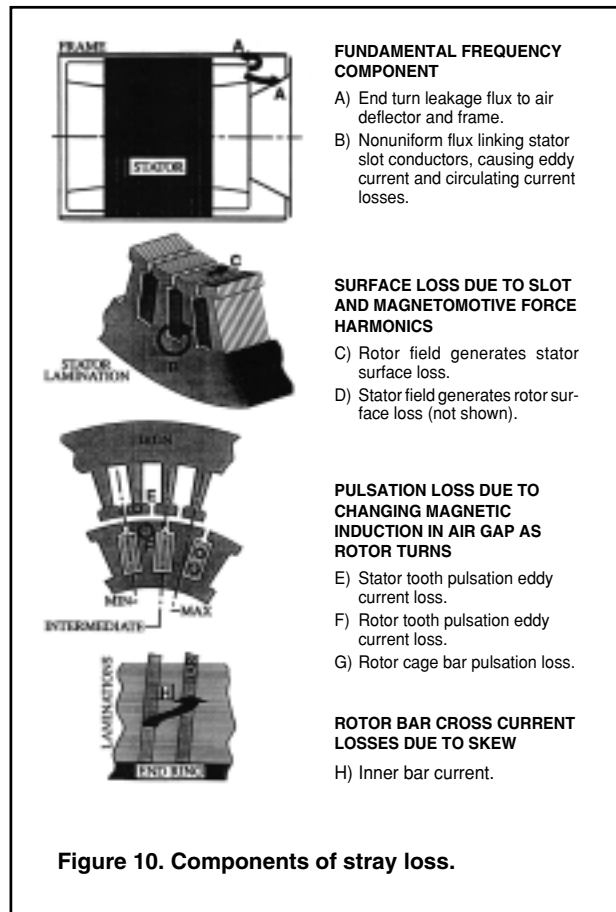

Figure 10. Components of stray loss.

Figure 11. Original Polyphase AC Winding Data Sheet

HP/kW	RPM	Poles	Manufacturer	
SLOTS		TYPE		VOLTS
COILS		MODEL		AMPS
GROUPING		STYLE		PHASE
URNS/COIL		AUX.DEVICE	EFF.	HERTZ
WIRE SIZE		LEAD LENGTH	# LDS	FRAME
WIRES IN MULTIPLE		DEG C RISE	DUTY	DEG C AMB
PITCH: 1 TO		SERIAL #		INS CLASS
CONNECTION		ENC TYPE		SVC FCTR
JUMPER		COIL	DENSITIES:	CMA
CORE LENGTH				A/MM ²
CORE ID				AGD
BACKIRON				THD
SLOT DEPTH				BID
TOOTH WIDTH				
LBS WIRE				
JOB NUMBER				
CUSTOMER				

MOTOR REPAIR PROCESSES

Most repair processes, if done improperly, can reduce motor efficiency. Conversely, doing them well will maintain and may even improve efficiency. It is also important to keep clear, concise written records throughout the repair process.

The main motor repair processes include:

- Preliminary inspection
- Dismantling the motor
- Documenting and removing the old winding and cleaning the core
- Rewinding the motor
- Mechanical repairs
- Reassembling the motor

Key points

- Most motor repair processes, done improperly, can reduce efficiency.
- Best practice motor repair methods can maintain and sometimes improve efficiency.
- Keeping an accurate written record of each repair is essential.
- Preliminary inspection can yield much useful information.

The following sections provide good practice procedures for each stage of the repair process, beginning with the preliminary inspection.

1 Preliminary inspection

The preliminary inspection forms an important part of the complete motor repair record and may yield vital clues about the cause of failure. It is important to include all data sources on a data card like the ones shown in Figures 11 and 12. In particular, record the following information:

Key points

- Motor nameplate(s) data
- Results of external inspection
- Customer input

1.1 Motor nameplate(s) data

- Record all the data on the nameplate. Some codes, numbers or letters which seem meaningless may be very important if it is necessary to contact the manufacturer for parts or information.
- Remember that there may be more than one nameplate. Some OEMs fit their own nameplates (which sometimes replace those installed by the motor manufacturer), and some repairers add a plate indicating the motor has been repaired previously.
- Check whether the motor is EPA standard (US) or EFF1 (Europe).
- Check whether motor is for use in hazardous environ-

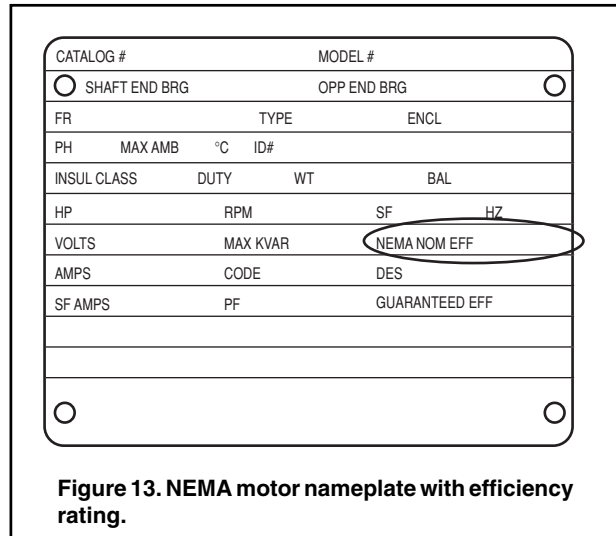

Figure 13. NEMA motor nameplate with efficiency rating.

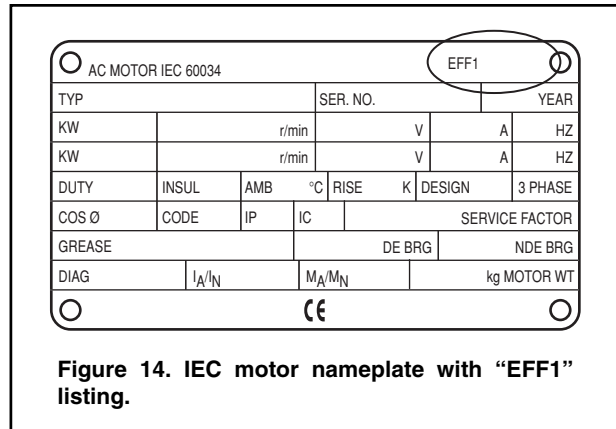

Figure 14. IEC motor nameplate with "EFF1" listing.

ments (EExd or EExe coded for IEC motors, UL or CSA coded for NEMA machines).

1.2 Results of external inspection

Look for and record:

- General condition—old/new, dirty/clean, etc.
- Cooling air ducts clear/obstructed—may have caused overheating.
- Shaft discolored (brown/blue)—sign of rotor overheating or bearing seizure.
- Parts missing, damaged or previously replaced/repairs—e.g., seals, stator cooling ribs, fan, fan cover, terminal box, etc.

1.3 Customer input

Customers may be able to provide:

- Operating environment—temperature, vibration, etc.
- Type of driven equipment.
- How many hours/day motor runs.
- Approximate motor load.
- How often it is started.



Figure 15. Motor with blocked cooling ribs.

- The type of starter used.
- Whether the motor has been rewound before.
- How long the motor has operated since new (or since last rewind).
- Unusual events—e.g., power outage, lightning strike, water damage, problem with driven equipment, etc.
- Power supply and starting
 - o Across line/direct on line
 - o Soft start
 - o Part winding start
 - o Inverter
 - o Wye-delta/star-delta

2 Dismantling the motor

Sometimes it is obvious from its outward appearance that the returned motor is not repairable and that a new one must be supplied. More often, however, the motor must be dismantled before this decision can be made. It is essential to dismantle the motor carefully and to keep adequate records to ensure that if the motor is repaired it can be reassembled correctly. Place all parts that are not to be repaired in a suitable bin or tray that is labeled with the motor serial number or job card number.

Key points

- Terminal box position, layout and connections.
- Orientation of end brackets and bearing caps.
- Bearing sizes, types and clearances.
- Axial position of rotor relative to stator (drive end or opposite drive end).
- Orientation of shaft with respect to the main terminal box.
- Careful rotor removal to prevent damage to air gap surfaces or winding.



As received

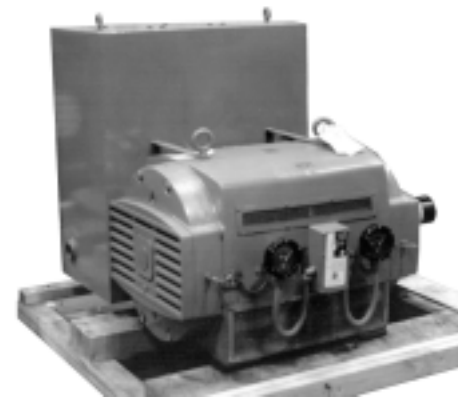

As shipped

Figure 16. This motor was reassembled with the shaft extension on the wrong end. Punch marks on stator frame and end bracket define orientation, preventing this problem.

- Internal inspection.
- Mechanical damage to components or signs of misuse.
- Motors with contamination

2.1 Terminal box layout and connections

- Record markings on both winding leads and terminals.
- Record positions of any links between terminals (make sketch).
- Check that insulation on winding leads immediately adjacent to terminals does not show any signs of overheating (discoloration or brittleness). If it does, replace the leads. Overheating may have been caused by a poor connection.
- Confirm that all terminals are firmly crimped or brazed to winding leads.
- Record size and type of lead wire.
- Record lug size and style.

2.2 Orientation of end bracket and bearing caps

End bracket and stator frame rabbet/spigot fits are not always perfectly circular. End brackets and bearing caps should be installed in exactly the same positions as originally fitted. Therefore, indelibly mark all end brackets and stator frames at both ends of the motor (e.g., by punch-marking the components with a center punch) before dismantling the motor (see Figure 16).

2.3 Bearing sizes, types and clearances

Most motors have a ball bearing at each end. Some may have a roller bearing at the drive end to increase the radial load capacity, or thrust bearing(s) for high axial loads. Always fit new bearings of the same type as those removed, unless they were misapplied.

The following items are critically important in bearing selection:

- Bearing enclosure
- Fit and tolerance
- Precision class
- Internal clearance
- Load application
- Type of lubricant

2.4 Axial position of rotor relative to stator (drive end or opposite drive end)

The rotor should be centered axially within the stator core. If it is displaced axially, centering forces will exert pressure on the bearings. If it is displaced beyond the end of the stator core, magnetizing current will increase. Note position of axial thrust washer when dismantling the motor (i.e., DE or ODE).

2.5 Orientation of shaft with respect to the main terminal box

Document the mounting position of the shaft in relation to the leads (F1 or F2). There many ways to do this. Some

repairers describe this as “leads left facing shaft” or “shaft right facing leads.”

2.6 Careful rotor removal to prevent damage to air gap surfaces or winding

The rotor presents a considerable overhung load when one end bracket has been removed. Allowing it to scrape along the stator bore during rotor removal can damage the air gap surfaces of both stator and rotor and increase losses. Winding damage can also result. An effective way to remove and replace rotors in horizontal motors is by using a rotor removal tool (see Figure 17).

2.7 Internal inspection

Look for and record:

- Water or dirt ingress.
- Condition of stator and rotor cores—damage or overheating.
- Condition of winding—discoloration, type of failure.

2.7.1 Water or dirt ingress

Loose dust, watermarks or rust on internal surfaces, particularly in the bottom of the motor, may have been caused by water or dirt ingress, which can contribute to failure. However, on totally enclosed (TE) or totally enclosed fan cooled (TEFC) machines, watermarks or rust can be caused by condensation of the air inside the machine as it cools down.

2.7.2 Condition of stator and rotor cores—damage or overheating

The stator and rotor cores may have been damaged in a number of ways including the following:

- **Core rub**, often due to failure of one of the motor bearings or rotor pullover caused by excessive radial load. This smears the air gap surfaces of the laminations together and can increase eddy current loss. Depending upon the extent of the damage, the motor may not be repairable.



Figure 17. Rotor removal using a rotor removal tool.

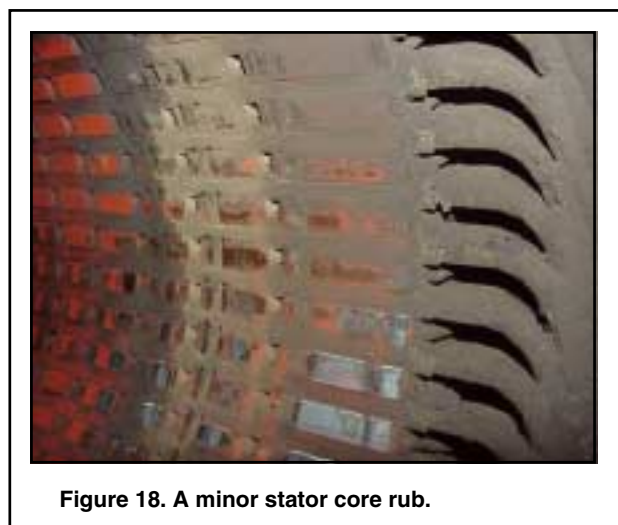

Figure 18. A minor stator core rub.



Figure 19. A major core rub; not repairable unless core is dismantled and repaired.

- **Major mechanical damage** to either the stator or rotor core. Pieces missing or fused together may sometimes be caused by a major electrical fault, such as a short circuit inside the slots. Any application with an ungrounded system or poor ground fault protection is particularly prone to this type of damage. If such damage has occurred, weigh its effect on motor efficiency and performance when considering a repair (see Figure 20).
- **Serious overheating** of the stator or rotor cores. If the interlaminar insulation is damaged, eddy currents will increase, causing excessive iron losses (see Figure 21).

Note: Eddy current losses follow a square law with respect to heating—i.e., if the eddy current doubles, the heating effect increases four times. Therefore, a small increase in eddy current loss can have a large effect on motor temperature and efficiency. Serious overheating of the core is sometimes evident from discolored air gap



Figure 20. Major mechanical damage to the stator bore; not repairable unless the core is restacked or replaced.



Figure 21. Overall discoloration of the stator winding—usually indicates excessive temperature. Check load, power supply and cooling.

surfaces, which may range from light straw to various shades of blue, depending upon the temperature reached.

2.7.3 Condition of winding—discoloration, type of failure

Overheating of the winding does not normally constitute irreparable damage, but the repairer should carefully inspect the windings and try to determine the cause of failure.

A winding that is evenly discolored at both ends may indicate a failure due a ventilation problem, overload or low voltage. Check the load conditions with the customer; a motor with greater power may be needed for the application. In that case, rewinding the old motor may result in another failure due to overload, possibly within the guarantee period offered by the repairer.

Most winding failures have many possible causes, and diagnosing these is beyond the scope of this guide. Consult EASA's book *Root Cause Failure Analysis*. Excellent photographs of different types of winding failure also are available in the EASA brochure "Failures in Three-Phase Stator Windings."

2.8 Mechanical damage to components or signs of misuse

Mechanical damage may affect motor performance. Look for:

- Damage to fan or fan cover
- Damaged or blocked cooling ducts/channels/ribs
- Shaft discoloration adjacent to either bearing (overload or misalignment)

2.9 Motors with considerable contamination

If the exterior is packed full of contaminants, address maintenance procedures or consider a different enclosure. If the winding is packed full of contaminants, the enclosure may not be suitable for the operating environment.

3 Removing the old winding and cleaning the core

There are four elements to this task:

- Recording the winding details on appropriate data cards or sheets (see Figures 11 and 12)
- Core loss testing
- Removing the old winding
- Cleaning the stator core in preparation for rewinding

Although removal of the old winding and cleaning the core are necessarily carried out sequentially, recording the winding details is a coordinated activity carried out both before and during winding removal. Likewise, core loss testing is carried out at fixed points throughout the process.

3.1 Recording the winding details

It is important to record the full details of the old winding accurately and permanently (see Figures 11 and 12). It is a good idea to collate all the winding data gathered over time into a winding data bank. The data to record are listed in the key points; the following explanatory notes may also be helpful.

Document the appropriate fields to ensure that the winder can duplicate the winding, and the engineer can confirm its suitability.

Note: If the motor has been rewound previously, the winding may not be the original and may not be the correct one for the motor. Try to verify observed data from another source (e.g., your own data bank, the EASA database or the manufacturer).

Key points—recording the winding details

- Winding configuration (lap, concentric, single, two or three layers, etc.)
- Number of slots
- Number of poles
- Number of phases
- Number, size and marking of leads
- Turns/coil
- Grouping
- Coil pitch
- Connections
- Coil extension/overhang—connection end
- Coil extension—non-connection end
- Number and size of wires in each coil

3.2 Core loss testing

Commercial core loss testers can give an indication of whether or not the stator core losses have been increased by the rewind process. They normally will not record the same core loss as would be measured during a load test on the same machine. One reason for this is that the distribution of the flux induced by the tester in the core is not the same as that induced by the machine's winding, particularly

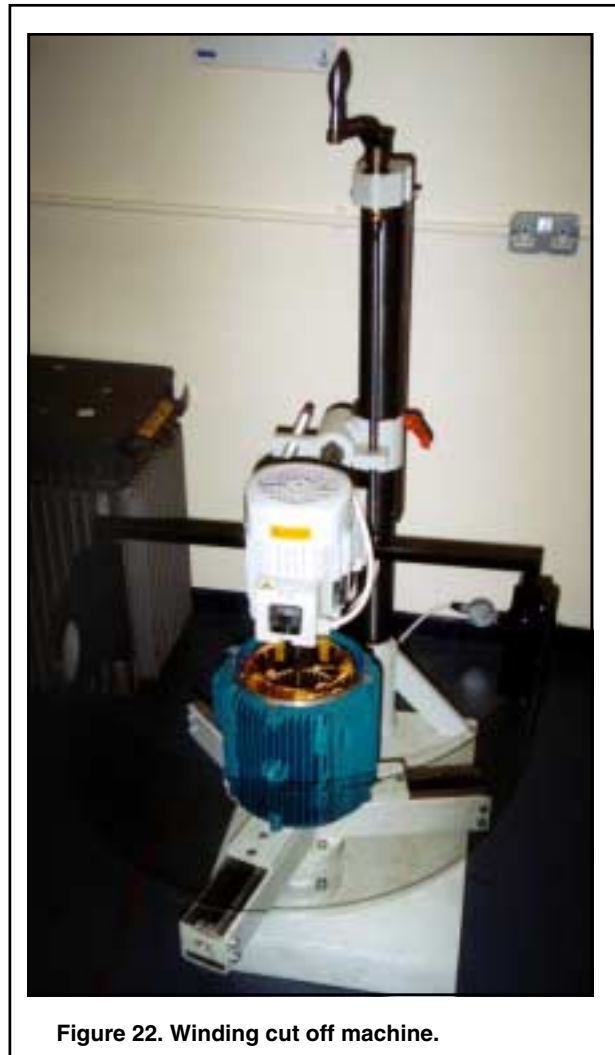

Figure 22. Winding cut off machine.

when the rotor is removed. Inaccuracies tend to worsen approaching the operating limits of the tester, so always use testers well within the manufacturer's recommended operating range.

Core loss testers can be useful provided that the same tester at the same setting is always used for each test on a given core.

Key points—core loss testing

- Conduct all tests using the same core tester.
- Make sure the tests are conducted well within the manufacturer's recommended operating range for the tester being used.
- Carry out tests:
 - Before burnout
 - After the core has been cleaned prior to rewinding.
- Remember that figures obtained are comparative, not actual losses.
- If the core loss increases by more than 20%:
 - Make sure the settings of the core loss tester have not

been changed and repeat the test.

- If the repeat test confirms the increased loss, repair the core or consider replacing it.

3.3 Removing the old winding

3.3.1 Step 1–Cut off one coil extension (usually the opposite connection end)

Cut off the coil extension of the winding as close to the stator core as possible without damaging the stator core. A number of cutoff machines are available commercially for this purpose (see Figure 22). Regardless of the method used to cut off the coil extension, be careful not to damage the laminations.

3.3.2 Step 2–Remove the old stator winding

The varnish and the insulation must be broken down before the windings can be removed from the stator core. This is commonly done with a controlled temperature burnout oven.

Note: If removing the windings requires excessive force or damages the laminations, the burnout process was not done at a suitable temperature. The best step at this point is to repeat the burnout cycle.

3.3.3 Core damage caused by overheating

The coils must be heated sufficiently to burn out the old insulation from the windings without damaging the interlaminar insulation of the stator core. The temperature required depends on the type of insulating varnish used, with epoxy resins usually requiring the highest temperature.

The stator core is made of thin steel laminations that are insulated from one another by an oxide coating or an organic or inorganic varnish. This interlaminar insulation can be damaged if the stator core gets too hot, resulting in increased iron losses and reduced motor efficiency.

All satisfactory results in EASA/AEMT study were achieved with a burnout temperature of 700° F (370° C).

3.3.4 Burnout using a controlled temperature burnout oven

This method is the most tightly controlled of any of the burnout processes. Properly done, it ensures that the stator core will not reach a temperature that could damage the interlaminar insulation. It is important to **set the oven temperature to monitor the temperature of the stator core**, and to follow the oven manufacturer's instructions regarding cleaning and safety (see Figure 23).

Loading cautions for burnout ovens: Do not stack stators in the oven; the temperature of the stators on top may be increased by the burning stators underneath. Do not place stators in the oven with the bores vertical; this is especially critical with aluminum frames.

3.3.5 Removing the old winding

When the heating process is complete, pull out the old winding taking care not to damage the core (e.g., by splaying the end teeth outwards).



Figure 23. Controlled temperature burnout oven.

Key points—removing the old windings

- Cut off one coil extension using a winding cutoff machine.
- Burn out old insulation at appropriate temperature in a controlled-temperature burnout oven set to monitor core temperature.
- Do not overheat the core.
- Remove the winding without damaging the core.
- Caution: Some motors may have the connection brought out on both coil extensions.

3.4 Cleaning the stator core

After the old winding has been removed from the core, slot insulation and other debris may remain in the slots. This must be removed carefully to avoid damaging the core. If the teeth of the laminations at the end of the core have been pulled outwards during coil removal, reposition them with minimum force.

3.4.1 Methods of removing slot insulation

There are various ways to remove insulation from the slots following burnout. The following methods proved to be satisfactory in the EASA/AEMT study:

- **Careful scraping** using a sharp knife to separate the remaining pieces of slot liner material from the core.
- **High-pressure washing** using a commercial/domestic high-pressure washer.
- **Abrasive blasting** using mildly abrasive material such as walnut hulls, crushed corncobs or plastic beads. Blasting with more abrasive materials like sand, crushed flint, ceramic pellets or even glass beads may cause surface shorting of the laminations, which increases core and stray losses.



Figure 24. This core has been partially cleaned by using a high-pressure washer to remove the slot insulation debris.

- **Wire brushing** using a medium/soft wire brush.

Avoid using files or grinders to remove slot insulation. These can smear the laminations together and increase eddy current losses near the air gap surfaces of the core.

3.4.2 Damaged teeth at the end of the core

Sometimes teeth on the end laminations will be disturbed when the coils are removed. It is important not to hammer them excessively to get them back into position. The use of a soft-faced hammer with minimum force is recommended.

3.4.3 Damage to air gap surfaces of core

The air gap surfaces of the stator and/or rotor cores may have been damaged. The most common damage results in the laminations being smeared together.

If the damaged area is not extensive, the effect on losses or efficiency should not be significant. In cases of relatively minor damage, bumping the affected area axially will usually improve things. (This is sometimes called “watt-knocking, since it “knocks” the watts out of the core.) If this does not work, use a sharp knife to separate the laminations in the damaged area and treat them with insulating material of an appropriate temperature rating. Insulating varnish may also seep between the separated laminations when the new winding is impregnated, helping to restore the interlaminar insulation.

If the damaged area of the core is excessive, there is a risk that losses will have been increased significantly and that motor efficiency will be reduced. The best solution in such cases is to replace the core, or to dismantle, reinsulate and rebuild it.

Key points—cleaning the stator core

Satisfactory methods for cleaning stator slots include:

- Careful scraping with a sharp knife.
- High-pressure washing.
- Blasting with a mildly abrasive material.
- Brushing with medium/soft wire brush.

After cleaning the slots:

- Reposition damaged teeth
- Repair minor damage to air gap surfaces
- Replace or reinsulate and rebuild cores if major damage has occurred.

4 Rewinding the motor

In choosing a replacement winding the repairer has two options:

- Copy (duplicate) the winding already in the motor (provided it is the manufacturer’s original).
- Choose a different style of winding that will perform as well as or better than the original.

Most repairers have the ability to redesign motors to make them more energy efficient. Most of the time, however, the best way to maintain motor efficiency is to duplicate the original winding, while increasing the copper cross sectional area as much as possible and keeping the end turns as short as possible (certainly no longer than those of the original winding). Note, though, that in some designs, the coil extension is critical for heat dissipation. If it is too short, the temperature of the winding may rise, causing I^2R losses to increase.

When production volume justifies the cost, motor manufacturers use automatic coil winding and inserting machinery to produce motors with **concentric coil groups**. Repairers often find **lap windings** much quicker and easier to install. This section therefore sets out the basic rules (in terms of maintaining efficiency) for just two types of rewind:

- A “copy” (or duplicate) rewind
- Changing the original concentric winding to a conventional lap winding

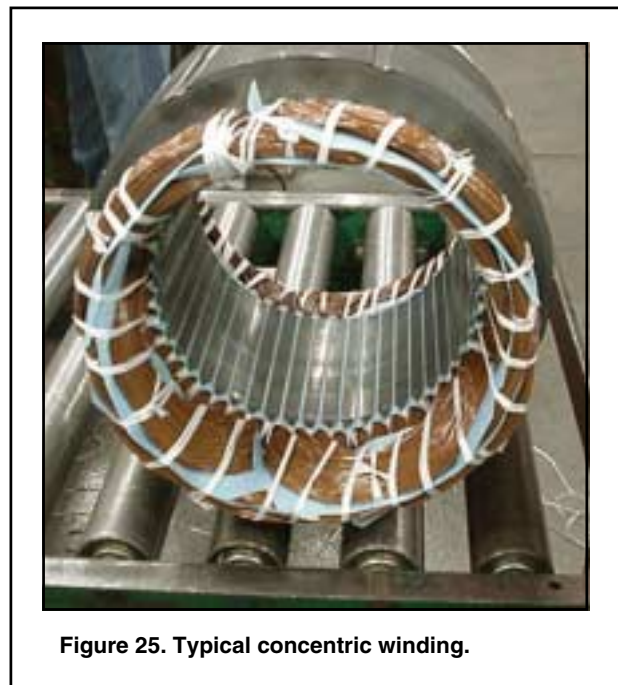

Figure 25. Typical concentric winding.



Figure 26. Typical lap winding.



Figure 27. Inserting coils into a 2-pole stator

4.1 Is the old winding the manufacturer's original?

Experienced technicians often can tell by looking at a winding that it was wound by the manufacturer. Even so, it usually is best to check the winding data on EASA's *Motor Rewind Data CD-ROM*. This resource, which is available to EASA and AEMT members, contains over 340,000 sets of data. If the repairer has a winding data bank, this may provide useful information as well.

There are other clues, however. For example, repairers rarely use concentric coil groups. Then, too, repairers often are more careful about layering wires neatly in coils than are manufacturers. They also tend to use larger lead wire sizes and more substantial phase insulation and bracing.

These differences are not a criticism of manufacturers' windings. They merely reflect the fact that manufacturers' winding processes are often wholly or partially automated, whereas almost all repair work is done by hand. Most service centers also try to prevent future failures of the motors they rewind by upgrading the coil bracing, insulation systems, etc.

4.2 Copy (duplicate) rewinding

If the details of the old winding have been recorded (see Section 3.1), and provided that it is the manufacturer's original winding, the core can now be prepared for rewinding. Even though the coil pitch (or pitches), turns/coil and the connections will be the same as those of the original winding, two changes could be made that will help to maintain or even slightly improve the efficiency of the rewound motor:

- Minimize the length of the coil extensions.
- Increase the copper cross-sectional area in each coil.

4.2.1 Minimize the length of the coil extensions

The coil extensions consist of "inactive" copper that merely connect the "active" conductors or coil-sides inside the slots. For most stator windings (especially in 2-pole and 4-pole motors) the copper in the coil extensions weighs more than the copper in the slots and contributes substantially to the total stator I^2R losses. It is therefore important to keep the coil extensions as short as possible. If the mean

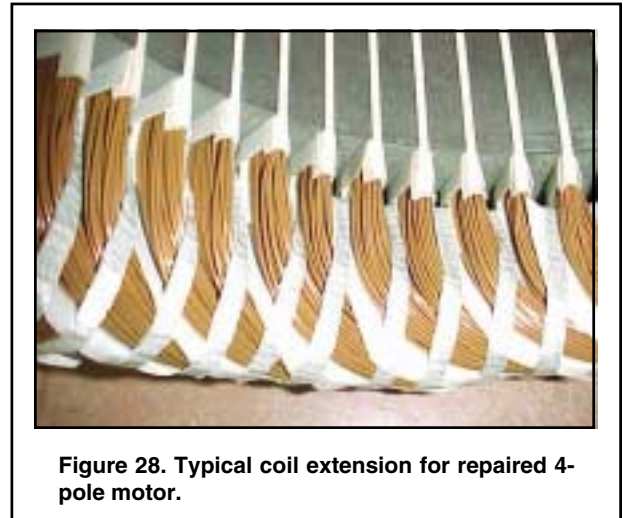

Figure 28. Typical coil extension for repaired 4-pole motor.

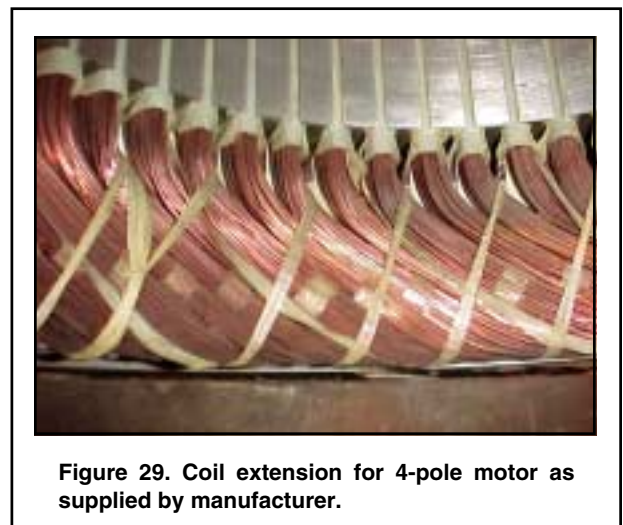

Figure 29. Coil extension for 4-pole motor as supplied by manufacturer.

length of turn (MLT) of the rewind exceeds that of the original, the I^2R losses will increase. Attention to the following rules will prevent this:

- Keep the coil extensions within the measured dimensions of the original winding.
- Do not extend the slot insulation beyond the slot ends any more than is necessary to prevent strain on the slot cell.
- Do not extend the straight portions of the coil sides any farther than is necessary to clear the slot insulation.

Reducing the length of the coil extension will reduce the amount of copper in the winding and reduce losses. If taken too far, however, this principle can make winding a stator difficult or even impossible. Cooling may even be affected—in extreme cases causing the motor to run hotter.

By careful specification of the winding and coil dimensions, it is nearly always possible to equal or improve the performance of the manufacturer's original winding in regard to copper losses. Record coil dimensions of the new winding.

4.2.2 Increase the copper cross-sectional area in each coil

It often is possible to increase the copper cross-sectional area in each coil when hand-winding motors that were originally machine wound, or when rewinding an older motor. The drawbacks are that it takes more copper and can add significantly to winding times if overdone. It also is harder (and may even be impractical) to do with energy efficient motors (EPA Act, EFF1 or premium efficiency grades). Where practical, though, increasing the copper cross-sectional area of each coil helps reduce I^2R losses and maintain (or improve) motor efficiency after a repair.

Experience will tell how much the copper area can be increased. The best method is to change conductor sizes in each coil, remembering that the slot fill (i.e., the cross section of copper in each slot/slot area) increases if fewer, larger conductors are used, but so does the difficulty of inserting the winding. Be sure to record the conductor sizes used in new winding.

Key points—copy rewinding

- Check that old winding is manufacturer's original.
- Use same winding configuration.
- Keep coil extensions as short as practical.
- Same (preferably less) length of overhang.
- Use same coil pitch (or pitches).
- Use same turns/coil.
- Use same (preferably larger) copper cross-sectional area.
- Use same or shorter MLT.
- Use same or lower winding resistance (temperature corrected).

4.3 Changing to a two-layer lap winding

Repairers often prefer to use lap windings because all

coils are the same. This is acceptable if the new winding has the same flux/pole as the original.

Single-layer lap windings are sometimes used for small-to medium-sized motors, because the coils are easier to insert and no separators are required. This allows more room for copper.

Double-layer windings distribute flux through the core better than single-layer windings. Replacing a double-layer winding with a single-layer winding will certainly reduce motor efficiency, so it is not recommended.

Lap windings should be appropriately short-pitched (i.e., the coil pitch must be less than the pole pitch unless the winding has only one coil per group). For more information and more detail on how to redesign a winding, see Appendices 1 and 2 as well as the EASA's *AC Motor Verification and Redesign Program*.

Advantages

- **Efficiency can be maintained or improved. The double-layer winding yields the best results.**
- Mean length of turn (MLT) can be made the same as, or less than, that of the original winding.
- All coils are the same.
- All coils have equal exposure to air flow for cooling.
- The magneto motive force (MMF) curve more closely resembles a sine wave. See Appendix 3 for more information.
- Phase insulation and coil bracing are more likely to be uniformly placed.

Disadvantages

- None, provided that the conversion is done correctly.

For further information, see EASA's *AC Motor Redesign and Verification* computer program.

4.3.1 Torque, flux and winding rules

The following rules are important when changing a winding configuration.

In an induction motor, torque is proportional to flux times current. Both can be affected by changes to the winding, and thus both can be affected by rewinding.

The voltage applied to each phase of the motor is opposed by (and almost equal to) the back emf (induced voltage in a coil caused by the conductors moving through or cutting field magnetic lines of flux). The back emf is expressed by the formula:

$$1) \quad E = 4.44 \times f \times N \times F \times K_d \times K_p$$

Where E = back emf/phase

f = frequency

N = number of series turns/phase

F = magnetic flux/pole

K_d = winding distribution factor

K_p = winding pitch factor

For the purposes of a rewind (other than for a different voltage or frequency) E and f are constants. That leaves three variables under the control of the repairer:

- N - the number of series turns/phase
- K_d - the winding distribution factor
- K_p - the chord factor (pitch factor)

The product of these variables must remain constant to satisfy equation (1) above, and this gives rise to the following important rules for a given winding configuration:

- Increasing the turns, the chord factor, or the distribution factor reduces the flux.
- Reducing the turns, the chord factor, or the distribution factor increases the flux.
- The flux/pole will remain unchanged if the product of the chord factor, the distribution factor, and the turns remains unchanged.

To maintain motor performance, both torque and efficiency, the flux/pole should remain unchanged.

The effectiveness of a winding in terms of optimizing motor performance (including efficiency) depends both on the type of winding used and its design, which needs to optimize K_p and K_d such that fundamental emf's per coil are maximized and harmonic emf's minimized.

Although this complex subject is outside the scope of this guide, there are some basic rules that may help service center personnel:

- Double-layer windings (two coils per slot) give better results than single-layer windings.
- Some coil arrangements (notably skip slot) give much worse results than conventional or consequent-pole windings.
- Full-pitched coils generate higher harmonic emf's than short-pitched or over-pitched coils.
- In general, double-layer, short-pitched lap windings give the best results. Single-layer, short-pitched lap windings are sometimes used on small/medium size machines, but should never be used to replace a double-layer lap winding.

For more information about chord factor and distribution factor, see Appendix 1.

4.4 Completing the winding

After fully inserting the winding, connect the coils and leads to match the original connections exactly (if a copy or duplicate rewind) or appropriately for the replacement lap winding. Use connection leads that are as large as practical and mark all of them correctly. Brace the coil extension either as the manufacturer's original winding or better (i.e., more rigid).

After checking the coil extensions a final time, perform winding resistance, insulation resistance, phase balance and voltage withstand tests as described in section 4.5.

4.5 Winding tests

Test the winding using the winding resistance tests and phase balance tests.

4.5.1 Winding resistance tests

Measure the resistance of the first coil group wound and compare it with the calculated resistance. If possible, measure the resistance of a coil group from the original winding for comparison.

Measure the ambient air temperature (T_a) with the winding at room temperature. Correct both resistances to a convenient common reference temperature (normally 25° C) using the formula:

$$R_x = \left(\frac{234.5 + 25}{234.5 + T_a} \right) \times \text{Measured resistance}$$

Where

R_x = corrected winding resistance

T_a = ambient air temperature

The corrected value of resistance of the new coil group must be equal to or lower than that of the original coil group.

When the stator is fully wound, measure and record the resistance of each phase (or between leads) as well as the ambient temperature. Resistance of each should be equal within 5% (see Figure 30).



Figure 30. Measuring the resistance of a coil group. Note that meter leads are clamped securely to bare conductors; also note the ambient temperature thermometer.

4.5.2 Phase balance (or surge comparison) tests

A surge comparison test will detect unbalanced windings, whether they are due to shorted turns or unbalanced circuits (which would result in circulating currents). Either of these problems will increase stator I^2R losses.

Perform this test after the rewind but before impregnation. The test ensures that all three phases are wound and connected in the same way. The test works by applying identical voltage pulses simultaneously to two phases of the winding and recording the voltage decay on a twin beam oscilloscope. Identical traces for each phase indicate that the decay curves for all phases are the same and that the phases are thus identical. Two traces that do not appear identical indicate a fault that must be found by inspection.

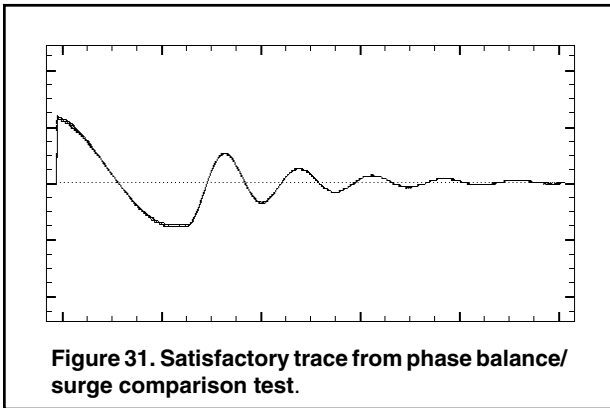

Figure 31. Satisfactory trace from phase balance/surge comparison test.

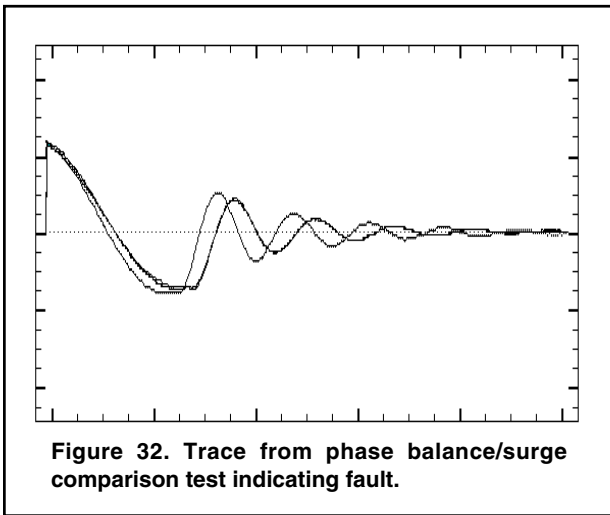

Figure 32. Trace from phase balance/surge comparison test indicating fault.

Key points—phase balance/surge comparison tests

- Perform on completed winding before impregnation.
- Test compares decay rate of identical voltage pulses applied simultaneously for 2 winding phases.
- Trace pattern indicates phases identical (okay—identical traces) or different (fault—traces do not match).
- Trace pattern gives guidance to type of fault (see equipment manufacturer’s guide).

4.5.3 Ground test/hipot test

For windings rated above 250 volts, larger than 0.5 hp (.37 kW):

- AC hipot test voltage: 1000 volts +2 times rated voltage (2000V minimum per IEC)
- DC hipot test voltage: 1.7 times the AC test voltage, above

The hipot test voltage is intended as a proof test and should not be repeated. If an additional hipot test is required, it should be performed at 85% of the test voltages given above. Subsequent tests should not exceed 65% of the test voltages given above.

Note: For old windings, limit the hipot test voltage to 60% of the above test values.

4.6 Impregnation

Impregnating the winding with varnish and subsequently air drying or baking this varnish until it is cured serves the several purposes:

- It provides a mechanical bond between conductors.
- It increases the dielectric rating of the insulation.
- It protects the winding from moisture and contamination.
- It fills the air spaces between conductors (particularly in the slots).

The last property is important in terms of motor efficiency since it helps transfer the heat generated in the conductors more easily to the stator core and frame, and thus keeps the winding temperature down. The impregnation process should be carefully controlled to minimize voids and maximize slot fill. Poor impregnation can result in increased winding temperatures, and therefore increased resistance and lower efficiency.

$$\begin{aligned} \text{Lower winding temperature} &= \text{lower resistance} \\ &= \text{lower } I^2R \text{ losses} \end{aligned}$$

4.6.1 Varnish types and classifications

Insulating varnishes are classified by long-term temperature withstand capabilities and types of material. Temperature withstand capabilities are shown in Table 3.

TABLE 3. TEMPERATURE WITHSTAND CAPABILITIES

Insulation class	Maximum allowed temperature (IEC 60034-1; 1998)		Maximum allowed temperature (NEMA MG1-12.43)	
	°C	°F	°C	°F
A	105° C	221° F	105° C	221° F
E	120° C	248° F		
B	130° C	266° F	130° C	266° F
F	155° C	311° F	155° C	311° F
H	180° C	356° F	180° C	356° F
C	>180° C	356° F		

Most modern varnishes are Class F or H. It is important to use a varnish of at least Class F, even if the motor is of a lower insulation class (e.g., Class B), to compensate for hot spots or unusual load conditions.

Depending on the treatment used, the goal is to fill the voids among conductors as completely as possible. Avoid a large buildup of material, however, and wipe excess varnish from the bore before placing the stator in the bake oven.

5 Mechanical repairs that can affect motor efficiency

5.1 Repairs to cores

a) Stator

- Grinding damaged surfaces of the core.
- Excessive grinding of the core.
- Using undue force to reposition splayed teeth.

- Reducing the number of laminations.
- Improper restacking

b) Rotor

- Grinding the surface.
- Machining the rotor with a blunt tool or at incorrect surface speed (i.e., smearing laminations together).
- Excessive air gap
- Failure to detect or properly repair broken rotor bars or end rings.

5.2 Shaft repairs

- Failure to machine rebuilt bearing seats to the correct size for bearings.
- Shaft replacement using material with different magnetic properties.

5.3 Housing repairs

- Repairs to stator frame or end bracket rabbet/spigot fits that reduce stator/rotor concentricity.
- Failure to machine rebuilt bearing housing to the correct size for the bearing.
- Fitting a new stator frame that is too tight a fit onto the stator core (increases rotational loss in core). Rule of thumb is that interference fit should be 0.004 - 0.006 inches (0.10 - 0.15 mm). If it is too loose, the heat transfer from the core will be inhibited, and stator winding losses will increase.
- Failure to clear blocked airways or cooling ducts.
- Failure to repair broken cooling ribs, or to replace missing ones.

5.4 Bearings and seals

- Selecting incorrect bearings.
- Installing bearings incorrectly.
- Incorrect bearing lubrication (wrong grease, mixed greases, too much grease).
- Fitting wrong type of seal.
- Incorrectly fitted seals.
- Failure to lubricate (or poorly lubricating) seals.

5.5 Fans and fan covers

- Installing incorrect fan, or locating the fan or fan cover in the wrong position (improper clearance between the fan and fan cover).
- Not replacing damaged fan (i.e., missing/broken blades).
- Installing an incorrect fan cover.
- Not replacing broken (damaged) fan cover.
- Not ensuring that the fan inlet is free from dirt or other material that might reduce air flow.

6 Reassembling the motor

Certain steps of the assembly process can impact the motor's tested efficiency.

- **Bearing lubrication.** Foremost among these critical steps is the quantity of grease used in the bearing cavity. The EASA/AEMT study found that excess grease can increase friction losses on the order of 500 watts. The motor may have to run 8 hours or longer to purge enough excess grease to reduce these losses. Cavity design, shaft-to-bracket clearances, and grease viscosity all affect the ability of the motor to purge excess grease. Consequently, the time required for a particular motor to normalize friction losses cannot be predicted.
- **Thrust washers.** Particularly in cases where the bearing is tight in the housing, the assembly process may actually preload the bearings, increasing friction loss until the motor has thermally cycled several times. Running the motor for extended periods without full load will not alleviate this condition, as thermal expansion of the shaft is minimal until the motor approaches full-load operating temperature. Ensure that the thrust washer is installed correctly.
- **Fans and air baffles.** Placement of the external fan (of TEFC/IP 54, IP 55 motors) can affect the cooling effectiveness and therefore the winding resistance. For ODP (IP 11, IP 12) motors, the relative position of rotor fan blades and the air baffles is also likely to affect winding temperature. Leaving the air baffles out of the reassembled motor can have a significant effect on the cooling system. Directional fans, of course, must be mounted correctly for the direction of rotation.
- **Handling.** Physical damage to the rotor or stator air gap surface may also increase the stray-load losses. Rough handling can damage the rotor or stator air gap surface, which could even increase the respective core losses.
- **Painting.** Finally, make sure ventilation openings do not get clogged when the motor is painted. While this may seem a small point, it is especially possible when rodent screens are installed over the openings.

7 Repair tips

Much of the information in this section was summarized from other parts of this guide as a convenience for service center personnel. The material on "Confirming the integrity of a repair" should be especially helpful when circumstances make it impractical to perform more complete test procedures.

7.1 Motor losses and efficiency

It is important to understand why certain repair processes can affect motor efficiency, and how best repair practices can help maintain or even improve efficiency. First, though, it helps to recall that efficiency is a measure of how much input energy (electricity) a motor converts into useful work versus how much it wastes (heat). The wasted energy, most of which is given off as heat (called losses), has several components: stator winding losses, stator core losses, rotor losses, and stray load losses (see Figure 33).

7.2 Losses: Higher efficiency means less heat

In designing energy efficient motors, manufacturers try to reduce losses (wasted energy given off as heat). Their goal,

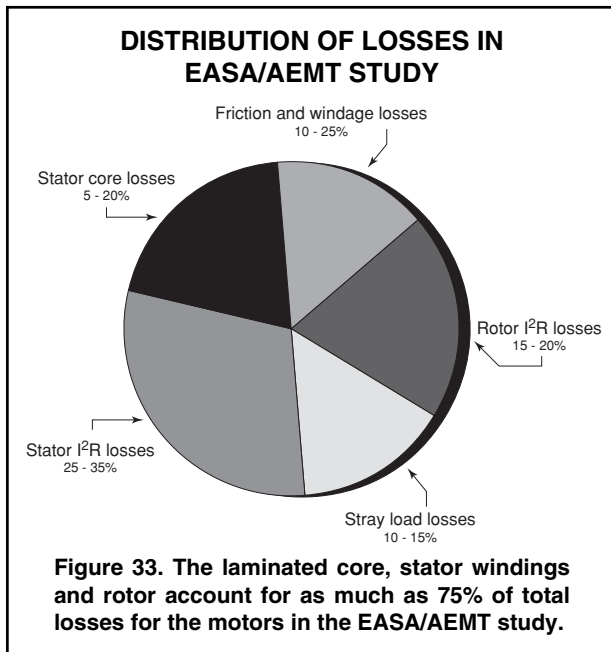

therefore, is to produce a motor that operates with minimal temperature rise. To achieve this, they address the areas where power is lost—to heat, friction or windage. They design longer stator cores, for instance, with correspondingly longer rotors or use better grades of electrical steel to decrease core losses. They also add more copper to windings (increase slot fill) to reduce copper losses.

These changes help lower the temperature of the winding, permitting the use of smaller fans. This increases efficiency by minimizing the horsepower diverted to cooling the motor. As an example, most external fans of totally enclosed, fan-cooled (TEFC) energy efficient motors are now as small as possible to do the job.

The lesson for service centers is that repair practices must not increase overall losses, and preferably should help to reduce them. In some cases, repairers can apply the same principles as motor designers to reduce losses and enhance efficiency.

7.3 Breaking it down: critical areas

In terms of maintaining or improving motor efficiency, certain repair procedures are critically important. These include: the burnout process, coil removal and core preparation, wire size, mean turn length, winding resistance, bearings, and windage.

7.3.1 The burnout process

The stator core is composed of laminations—thin pieces of steel coated with insulation to reduce eddy-currents in the core. Assuming the failure did not blow a hole in the core (thereby reducing its mass) or fuse laminations together, the next concern is to burn out the windings at an appropriate temperature.

The interlaminar insulation may be an organic, chemical or oxide coating. Newer motors are more likely to have C-5 (inorganic) lamination insulation that can withstand higher

temperatures than that of older motors.

Because winding insulation materials burn at lower temperatures than the interlaminar insulation, the burnout process—properly done—will not harm the interlaminar insulation. EASA's *Tech Note 16* recommends that core temperature not exceed 680° F (360° C) during burnout, unless the core is known to be C-5 coreplate (inorganic). In that case the core temperature should not exceed 750° F (400° C) during burnout. All satisfactory results in the EASA/AEMT study were achieved with a burnout temperature of 700° F (370° C), measured at the stator core.

Some lower grade lamination insulation processes require extreme caution and may not be suitable for burnout. These may include oxide steam-bluing, some waterborne varnishes, and some lower-grade organic varnishes.

The burnout oven should be fitted with a chart-recorder to document that each motor is burned out at a safe temperature. The temperature probe should be attached to the stator core during the burnout process.

Loading cautions for burnout ovens: Do not stack stators in the oven; the temperature of the stators on top may be increased by the burning stators underneath. Do not place stators in the oven with the bores vertical; this is especially critical with aluminum frames.

7.3.2 Core testing

The best safeguard against burnout-related problems is to perform a core loss test *before* burnout and *after* the core has been stripped and cleaned. Commercial core loss test equipment can simplify the process, or a loop test (also called a “ring flux test”) can be performed using the procedure in the *EASA Technical Manual*. (For more information, See 3.2.)

7.3.3 Coil removal

The stripping process directly affects motor efficiency. If the stator laminations are damaged during coil removal (e.g., teeth flared, end laminations buckled from excessive force or heat, etc.), the core losses and stray losses will increase. To avoid this, burn out the core at sufficient temperature to break down the winding insulation fully, so the coils can be removed without undue force.

When removing the coils, pull them away from the bore at a slight angle to keep the conductors from snagging or bending the end laminations. If a coil is difficult to remove, reduce the possibility of damage by applying uniform pressure to the teeth spanning it. (*Remember, splayed teeth will increase stray losses.*)

Burning out a core at too low a temperature often increases stray losses due to the physical damage inflicted on the core when the coils are removed. Burning out the stator at sufficient temperatures will prevent this problem. In addition, safe burnout temperatures will not increase eddy current losses because they will not damage interlaminar insulation.

7.3.4 Core preparation

Keep filing and grinding to the minimum required to correct damaged areas. Removal or shorting of laminations

will increase core losses. Unless corrected, severe core damage due to motor failure (e.g., rotor rub resulting from a failed bearing) will decrease efficiency. Carefully weigh this against the customer's need to return the motor to service. In some cases, repair may be a stopgap measure until a replacement motor can be obtained.

7.3.5 Wire size

When current passes through a conductor, I^2R losses are generated in the form of heat. For a given current, a larger conductor will heat up less than a smaller one. The cross-sectional area of the paralleled conductors determines the amount of copper in a motor. Based on current density, this is reported as circular mils per amp (CMA) [amps per mm squared]. The lower the current density, the lower the I^2R losses. Where possible, it is better to form a conductor with fewer wires of a larger diameter than with more wires of a smaller diameter, even if both conductors have the same the cross section.

7.3.6 Mean length of turn (MLT)

It is important that the mean length of turn (MLT) of the new winding is not greater (preferably less) than that of the old winding. Otherwise, the new winding will have higher resistance than the original and therefore higher I^2R losses. See Figure 5.

7.3.7 Winding resistance

It is often possible, by careful fitting, to produce a winding with a *lower* resistance than the original winding. Lower resistance reduces the I^2R losses, making the motor more efficient. All else being equal, a carefully fitted rewind motor *can* be of higher efficiency than the original. As a general practice, the service center should replace the stator winding with an exact duplicate of the one it removed. That means the same wire size, winding type, turns, span and coil extension.

Be careful to not increase the coil length to make the windings easier to install. That will increase total winding resistance. Increasing the coil extension also will increase total winding resistance.

When energy efficiency is the primary consideration, do not convert from concentric to lap without first calculating the MLT for both windings and proving that the total winding resistance will be lower.

When comparing lap and concentric windings, one consideration is the exposure of each coil to the air stream that cools the windings. Each coil of a lap winding has the same exposure to air flow, while the layers of a concentric winding vary in their ability to dissipate heat. "Buried coils" are best avoided: insulation life tends to be shorter and varnish impregnation is sometimes poor (see Figure 34). These drawbacks can apply to the middle layer of a 3-tier concentric winding. When copy-winding a 3-tier concentric winding, inserting the coils in the same manner as a lap winding balances the cooling effectiveness.

7.3.8 Winding type

Assuming no stator or rotor damage, and no reduction in



Figure 34. "Buried coils" in a lap winding.

the circular mils/amp, the potential efficiency of the motor should remain unchanged by the repair process. The next consideration is the winding type.

When production volume and economics justify it, manufacturers prefer using concentric windings (Figure 35), which can be machine-wound and require less labor. This benefits purchasers by keeping the cost of new motors economical. The drawback is that the turns in each coil of a

TYPICAL CONCENTRIC GROUP



Figure 35. In a concentric winding, each coil has a different span. Each span has a different chord factor, making the effectiveness of each coil different.

TYPICAL LAP GROUP



Figure 36. Lap winding showing all coils with the same span.

concentric winding are not equally effective.

Service centers that use predominantly hand-winding methods normally find it easier to use lap windings because the coils are all the same. (It takes a winder only slightly longer to insert the lap winding by hand than to insert a 2-layer concentric winding manually, and about the same insertion time as a 3-layer concentric.)

It is quite acceptable to replace a concentric winding with a lap winding (and it may even improve the performance of the machine) provided a few simple rules are followed. These are set out in section 4.3 and in the appendices.

(Note: As mentioned above, when energy efficiency is the primary consideration, do not convert from concentric to lap without first calculating the mean length of turn [MLT] for both windings and proving that the total winding resistance will be lower.)

As viewed from the ends of stator slots, a concentric winding may have coils with 2, 3 or 4 different spans (sometimes more). Each span has a different angle (expressed as a *Chord Factor*), which determines the effectiveness of the turns within that coil. Depending on the chord factor, X turns of a coil spanned at 1-9 will not have the same strength as X turns of a coil spanned at 1-10, or 1-8.

Chord factor (k_p) is described by the formula:

$$k_p = \sin(90 \times \text{teeth spanned}/\text{slots per pole})$$

or

$$k_p = \cos(((\text{pole pitch} - \text{coil pitch}) \times 90)/\text{pole pitch})$$

The following example will help illustrate the point. For some concentric winding designs, conversion to a lap winding offers more substantial improvements than for other designs.

Example : Concentric-to-lap conversion

A common 36-slot, 4-pole concentric design uses coil pitches of 1-8, 10, 12 (as in Figure 35). A suitable lap winding conversion would be calculated as follows:

24 turns per coil. Pitch: 1-8, 10, 12, resulting in chord factors of 0.940, 1.0 and 0.940, respectively.

$$24 (.940) + 24 (1.0) + 24 (.940) = 69.12 \text{ effective turns}$$

If a coil pitch of 1-9 is selected for the lap conversion:

$$69.12/3 = 23.04 \text{ effective turns per coil}$$

Actual turns per coil are calculated by dividing the effective turns per coil by ($k_p \times k_d$) [See Appendix 1 for a further discussion of chord factor (k_p) and distribution factor (k_d):

$$23.04/ (.985 \times .960) = 24.37 \text{ turns per slot}$$

Rounding down to 24 turns will result in a flux increase of 1%.

(Note: When a concentric winding has only 1 coil side per slot, and the replacement lap winding has 2 coil sides per slot, divide the turns per slot value by 2 to obtain the turns per coil.)

Depending on the coil pitch selected for the lap winding, the turns per slot for the lap winding might be fewer than, equal to, or greater than the number of turns per slot for the original concentric design.

The distance around the coil also changes with the span. A wider span requires a longer conductor—the additional length times the turns per coil. A longer conductor has greater resistance, so the total winding resistance partly depends on the coil span(s) selected.

The coil extension—the distance the winding protrudes past the core on each end—also affects the conductor length. Mean length of turn (MLT) can be controlled by careful fitting when the coils are made. The shorter this length, the lower the total winding resistance, which in turn increases the efficiency. With careful fitting, a diamond coil requires a shorter MLT than a round nose coil. While the difference in length is slight (about 3 - 7% less length in the end turn area), any decrease in resistance is beneficial.

As mentioned earlier, another advantage of the lap winding is that all coils have the same span, so each turn is equally effective.

7.3.9 Bearings

Bearings of C-3 internal clearance are the standard for most electric motors. A bearing with a contact seal can create more friction than a shielded, open or non-contact sealed bearing. The increased friction results in a slight drop in efficiency. To avoid degrading efficiency, it is good policy to use the open bearing style installed by the manufacturer.

Lubrication intervals, quantity and viscosity will also impact the efficiency of an electric motor. Follow the manufacturer's guidelines for each motor to maintain motor efficiency. The EASA/AEMT study found that over greasing a bearing, even by a small amount, increased the friction losses by about 500 watts. Excess lubrication not only reduces efficiency; it also causes local overheating, which

can shorten bearing life dramatically.

When the application and environment call for the reliability of sealed bearings, expect some increase in bearing temperature and friction losses. A better alternative may be to install non-contact seals or bearing isolators, which exclude contaminants without causing friction. Some bearing manufacturers also offer non-contact sealed bearings.

7.3.10 Windage

External fans are another potential source of efficiency loss. Windage varies among fan designs, depending on factors like diameter, the number and size of blades, material, and surface finish. The most important variable, however, is fan diameter.

All else being equal, a fan with a smaller diameter moves considerably less air $[(D2 / D1)^5]$ than one with a larger diameter. That means it takes more energy to drive a fan having a larger diameter. As an example, it would take 16% more hp to drive an otherwise identical replacement fan whose diameter is 5% larger than the original. That diverted hp is lost power, which reduces motor efficiency (see Figure 37).

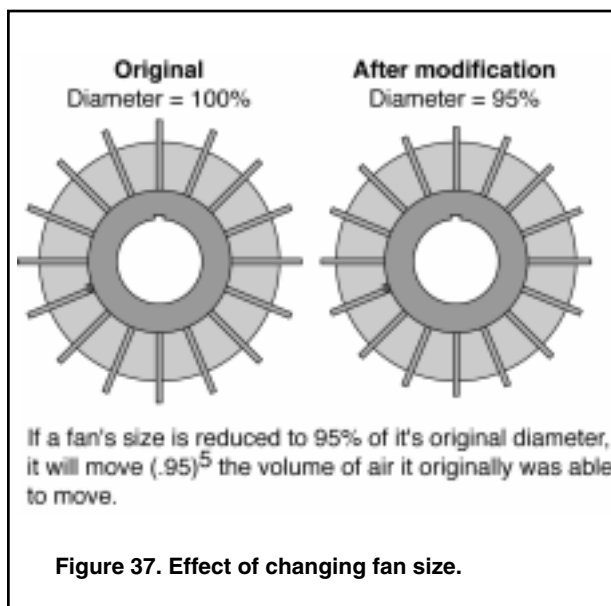

Replacing the original fan with a smaller fan of the same design is not recommended. Doing so will likely reduce air flow, causing the winding temperature to rise. That means increased losses and lower efficiency.

For these reasons, it is good practice to use an identical replacement for a damaged fan. Substituting a nonidentical fan may change the efficiency of the motor. Of course, if chemical processes or other considerations make the original fan design impractical, discuss alternatives with the motor manufacturer to avoid adversely affecting efficiency.

7.4 Confirming the integrity of the repair

Load testing is not always practical, considering setup time, test time, and power consumption. Fortunately, it is relatively easy to confirm the integrity of the repair by

checking for changes in the biggest loss components—core losses, copper losses, and rotor losses.

- Comparison of *before* and *after* burnout core tests proves whether or not the core losses have changed. An **increase of more than 20%** should be a cause for concern.
- An accurate resistance measurement verifies any change in copper losses.
- Rotor losses should remain unchanged, unless the rotor was damaged during the failure or its diameter was changed by machining.

Machining the rotor diameter to increase the air gap can reduce losses at the expense of power factor; however, too great an increase in air gap will increase losses. Service centers should use this procedure only if they know the design air gap. (If a rotor is machined during each of several repairs, sooner or later the air gap will become a problem. The repair history of motors is rarely known, so most service centers are reluctant to machine the rotor diameter.)

That leaves windage, friction and stray losses. Windage will not change unless the fan is modified or changed. That is easy to avoid. Friction should not change if identical bearings (and seals if appropriate) with appropriate fits are used. Substituting sealed bearings for open bearings will increase friction. Avoid over-greasing bearings for the same reason.

Stray losses are difficult to quantify, but one area where the repair process can impact them is during the coil removal. Flared lamination teeth will increase stray losses. The more force required to remove coils, the more likely that teeth will be flared. To avoid this, burn out stators at sufficient temperature to fully break down the insulation and allow for easy coil removal. All satisfactory results in the EASA/AEMT study were achieved with a burnout temperature of 700° F (370° C), measured at the stator core.

(Caution: Some lower grade insulation processes, such as steam-bluing and waterborne or lower grade organic varnishes, require extreme caution and may not be suitable for burnout.)

(This page intentionally left blank.)

Part 3: *Further Reading*

Bibliography	3-3
Appendix 1: Chord Factor and Distribution Factor	3-4
Appendix 2: Analysis of Winding Configurations	3-6
Appendix 3: Changing To Lap Windings–Examples	3-7
Appendix 4: Electrical Steels	3-9
Appendix 5: Repair–Replace Considerations	3-17

(This page intentionally left blank.)

Bibliography

- AS 1359.102.1-1997 *Rotating Electrical Machines - General Requirements - Methods for Determining Losses and Efficiency*. Standards Australia International Ltd., Sydney, Australia, 1997.
- AS/NZS 1359.5:2000 *Rotating Electrical Machines: High Efficiency and Minimum Energy Performance Standards*. Standards Australia International Ltd., Sydney, Australia, 2000.
- Beckley, Philip. *Electrical Steels for Rotating Machines*. Institution of Electrical Engineers, 2002.
- Bonnett, Austin and Yung, Chuck. *Guidelines for Repair/Replace Decisions and Performance Optimization*. Electrical Apparatus Service Association, Inc. (EASA), St. Louis, MO, 2001.
- BS 60034-2:1999 *Rotating electrical machines. Part 2: Methods for determining losses and efficiency of rotating electrical machinery from tests (excluding machines for traction vehicles)*. British Standards, London, United Kingdom, 1999.
- CAN/CSA-C390-98 *Energy Efficiency Test Methods for Three-Phase Induction Motors*. Canadian Standards Association (CSA), Toronto, Ontario, Canada, 1998.
- Christensen, Preben. *Tech Note 17: Stator Core Testing*. Electrical Apparatus Service Association, Inc. (EASA), St. Louis, MO, 1992.
- EASA/ANSI Standard AR100-2001: *Recommended Practice for the Repair of Rotating Electrical Apparatus*. Electrical Apparatus Service Association, Inc. (EASA), St. Louis, MO, 2001.
- EN 60034-2:1996 *Rotating electrical machines. Part 2: Methods for determining losses and efficiency of rotating electrical machinery from tests (excluding machines for traction vehicles)*. European Committee for Electrotechnical Standardization (CENELEC), Brussels, Belgium, 1996.
- Good Practice Guide: The Repair of Induction Motors—Best Practices to Maintain Energy Efficiency*. Association of Electrical and Mechanical Trades (AEMT), 1998.
- IEC Standard 60034-2: *Rotating electrical machines. Part 2: Methods for determining losses and efficiency of rotating electrical machinery from tests (excluding machines for traction vehicles)*. International Electrotechnical Commission (IEC), Geneva, Switzerland, 1998.
- IEC Standard 61972: *Dimensions and Output Series for Rotating Electrical Machines*. International Electrotechnical Commission (IEC), Geneva, Switzerland, 1998.
- IEEE Standard 43-2000: *IEEE Recommended Practice for Testing Insulation Resistance of Rotating Machinery*. Institute of Electrical and Electronics Engineers, Inc. (IEEE). New York, NY, 2000.
- IEEE Standard 112-1996: *IEEE Standard Test Procedure for Polyphase Induction Motors and Generators*. Institute of Electrical and Electronics Engineers, Inc. (IEEE), New York, NY, 1997.
- Standard of the Japanese Electrotechnical Committee JEC-2137-2000 Induction Machines*. Japanese Electrotechnical Committee, Japan, 2000.
- Montgomery, D. "Testing Rewinds to Avoid Motor Efficiency Degradation." *Energy Engineering*, Vol. 86, No. 3, 1989.
- NEMA Standards MG 1-1998 (Revision 3, 2002): Motors and Generators*. National Electrical Manufacturers Association (NEMA), Rosslyn, VA, 2002.
- Principles of Large AC Motors*. Electrical Apparatus Service Association, Inc. (EASA), St. Louis, MO, 2000.
- Rewound High Efficiency Motor Performance*. BC Hydro, M101, British Columbia, Canada, 1993.
- Rewound Motor Efficiency*. Ontario Hydro, TP-91-125 Ontario, Canada, 1991.
- Root Cause Failure Analysis*. Electrical Apparatus Service Association, Inc. (EASA), St. Louis, MO, 2002.
- Steel Products Manual: Electrical Steels*. American Iron and Steel Institute (AISI), Washington, D.C., 1983.
- Tech Note 16 (Revised): Guidelines for Maintaining Motor Efficiency During Rebuilding*. Electrical Apparatus Service Association, Inc. (EASA), St. Louis, MO, 1999.
- Thorsen, O.V. and Dalva, M. "A Survey of Faults on Induction Motors in Offshore Oil Industry, Petrochemical Industry, Gas Terminals and Oil Refineries." *IEEE Transactions on Industry Applications*, Vol. 31, No. 5, Sept./Oct. 1995.
- Walters, D.G. "Minimising Efficiency Loss Caused by Motor Rewinds." *Energy Efficiency Improvements in Electric Motors and Drives*. Springer, 1999.
- Yung, Chuck. *Rewinding Tips for Energy Efficient and Inverter-duty Motors*. Presented at the Electrical Apparatus Service Association convention, Chicago, IL, June 2001.

Appendix 1: Chord Factor and Distribution Factor

Chord Factor

The chord factor, also called pitch factor (K_p), is defined as the factor by which short pitching each coil of a lap winding would reduce the back emf, assuming the flux/pole is unchanged.

Mathematically, it is:

$$K_p = \text{Sin} [(coil\ pitch \times 90)/pole\ pitch]$$

or

$$K_p = \text{Cos} [((pole\ pitch - coil\ pitch) \times 90)/pole\ pitch]$$

(Note: Pole pitch is the number of slots per pole. Coil pitch is the number of teeth spanned by 1 coil.)

Example of pitch factor calculation:

A four pole 48 slot motor has a pole pitch of 12 slots (48/4). A full pitched lap coil would therefore span 12 slots (1-13). If the coil pitch were reduced to, say 10 slots (1-11), then:

$$K_p = \text{Sin} [(10 \times 90)/12] = 0.966$$

$$K_p = \text{Cos} [((12-10) \times 90)/12] = 0.966$$

This applies to both single-layer and double-layer (i.e., two coils/slot) lap windings, but the latter gives a better air gap flux distribution. The degree to which coils can be short-pitched will be dictated to some extent by the number of slots/pole and in any case should not be overdone.

Coil pitch is commonly described either as a fraction of full pitch or as the chord factor of the angle. Ideal pitch for a motor with 4 or more poles is 83% of full pitch, or a chord factor of 0.966. For a 2 pole winding, the use of a shorter pitch is usually required to make insertion practical; the preferred pitch is 67% or a chord factor of 0.866.

A chord factor table is included for convenience, but the following abbreviated table should prove instructive:

Fraction of full pitch	Chord factor
100%	1.0
83%	.966
67%	.866

Table 1 provides the pitch factor for many slots per pole combinations.

TABLE 1. PITCH FACTOR/CHORD FACTOR TABLE

Coil Span	SLOTS PER POLE													
	24	22	20	18	16	15	12	11	10	9	8	6	4	3
1-25	1.000	.990	.951	.866										
1-24	.998	.997	.972	.906										
1-23	.991	1.000	.988	.940	.831									
1-22	.981	.997	.997	.966	.882									
1-21	.966	.990	1.000	.985	.924	.866								
1-20	.947	.977	.997	.996	.957	.914								
1-19	.924	.959	.988	1.000	.981	.951								
1-18	.897	.937	.972	.996	.995	.978	.793							
1-17	.866	.910	.951	.985	1.000	.995	.863	.756						
1-16	.831	.878	.924	.966	.995	1.000	.924	.841	.707					
1-15	.793	.841	.891	.940	.981	.995	.966	.910	.809	.643				
1-14	.752	.801	.853	.906	.957	.978	.991	.959	.891	.766				
1-13	.707	.756	.809	.866	.924	.951	1.000	.990	.951	.866	.707			
1-12	.659	.707	.760	.819	.882	.914	.991	1.000	.988	.940	.831			
1-11	.609	.655	.707	.766	.831	.866	.966	.990	1.000	.985	.924			
1-10	.556	.599	.649	.707	.773	.809	.924	.959	.988	1.000	.981	.707		
1-9	.500	.541	.588	.643	.707	.743	.866	.910	.951	.985	1.000	.866		
1-8	.442	.479	.522	.574	.634	.669	.793	.841	.891	.940	.981	.966		
1-7	.383	.415	.454	.500	.556	.588	.707	.756	.809	.866	.924	1.000	.707	
1-6	.321	.349	.383	.423	.471	.500	.609	.655	.707	.766	.831	.966	.924	
1-5	.259	.282	.309	.342	.383	.407	.500	.541	.588	.643	.707	.866	1.000	.866
1-4	.195	.213	.233	.259	.290	.309	.383	.415	.454	.500	.556	.707	.924	1.000
1-3	.131	.142	.156	.174	.195	.208	.259	.282	.309	.342	.383	.500	.707	.866

Distribution Factor

The distribution factor, K_d , simply put, accounts for the fact that all coils in a group are not centered on the group. Instead of being concentrated, like a concentric winding, they are spread out, or distributed over a number of slots. Because the coils are distributed, they do not simultaneously contribute to the torque.

K_d is calculated from the formula:

$$K_d = \sin (nd^\circ/2)$$

or

$$K_d = n \times \sin (d^\circ/2)$$

where: K_d = distribution factor

n = number of slots per pole per phase

d° = number of electrical degrees between slots occupied by coils of the group*

It follows, then, that coil placement affects the actual distribution factor. Figure 1 shows the standard two layerlap winding where each slot contains a top and bottom coil and the number of coils per group = total slots divided by (poles times phases). There are two variations of full slot lap

windings where each slot contains only one coil side. In Figure 2, the coils are placed in adjacent slots, whereas in Figure 3 they are inserted skip-slot.

For a 48 slot, 4-pole winding, here are the results:

Standard lap winding:	$K_d =$.958
Full slot lap (sequential slots):		.966
Full slot lap (skip slot):		.991

The portion of the total stator bore covered by the group varies, depending on the method used. Therefore the K_d also differs. Not shown by the basic calculation is the effect when each slot no longer contains two coil sides. The result is a marked increase in harmonics. For the skip-slot method, the ratio of K_d to the fundamental harmonic is shown below:

Method	5 th Harmonic	7 th Harmonic
Standard lap	21%	17%
Skip slot lap	80%	61%

* Textbooks usually calculate K_d using electrical degrees per slot. That does not take into account the full slot lap winding.

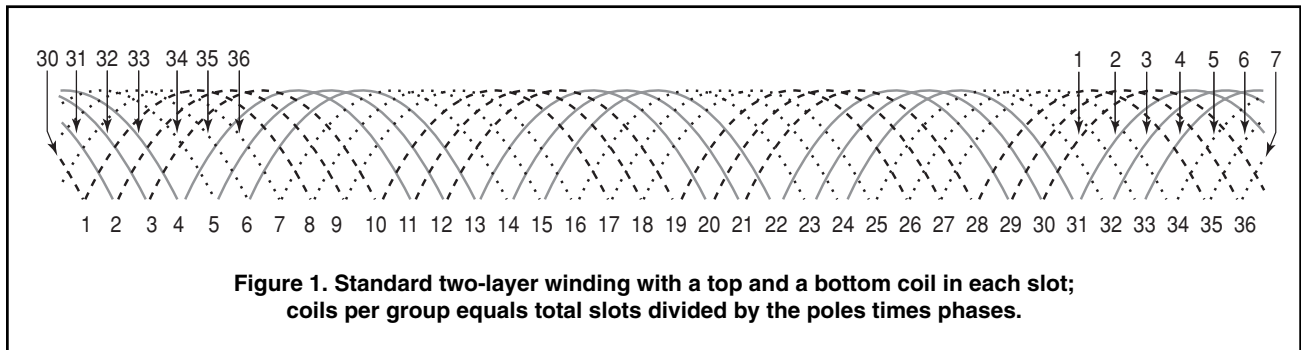

Figure 1. Standard two-layer winding with a top and a bottom coil in each slot; coils per group equals total slots divided by the poles times phases.

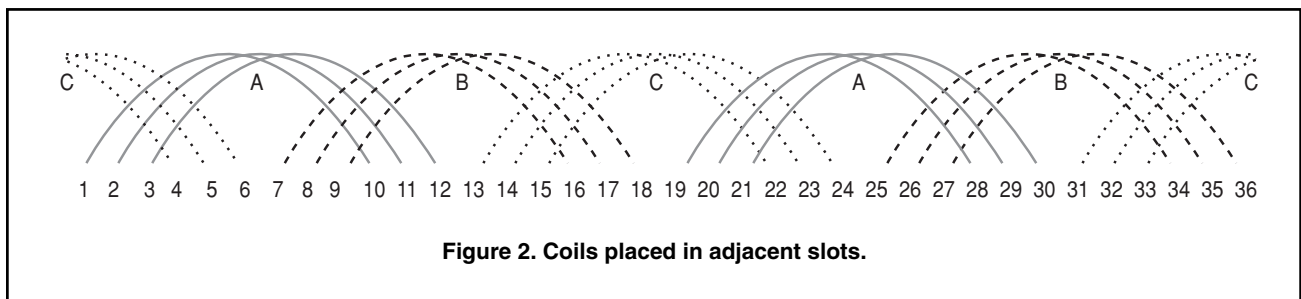

Figure 2. Coils placed in adjacent slots.

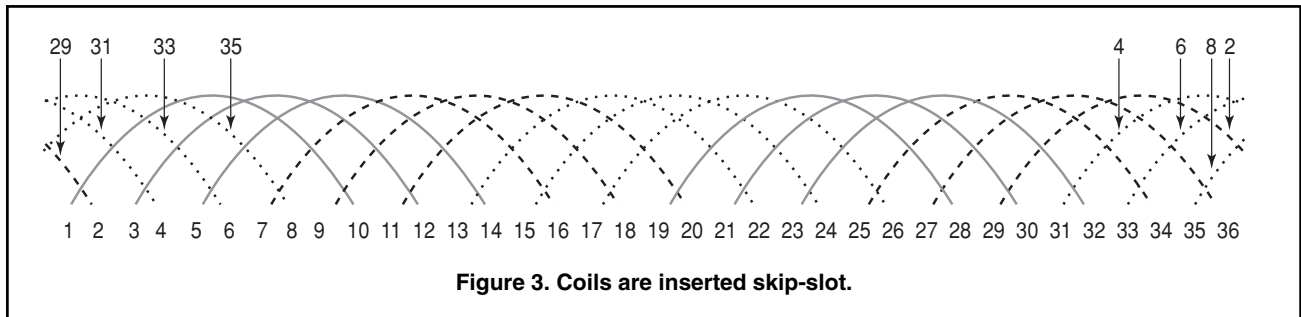

Figure 3. Coils are inserted skip-slot.

Appendix 2: Analysis of Winding Configurations

The following magneto motive force (MMF) plots are for typical winding configurations now in use. The variations in waveforms and deviation from a sinewave are influenced by the actual winding configuration and harmonic content. The lap winding has the best shape and the lowest stray loss content.

The concentric windings usually require more mean length of turn (MLT) to achieve the same amount of effective turns as a lap winding. Therefore, they will have the highest amount of I^2R loss. Because the concentric windings are normally machine inserted, they usually have a lower copper content in the slots, which also leads to increased I^2R losses for the same number of effective turns. In many cases the lap winding will be quieter for the same slot combination. The ideal winding configuration will have:

- Minimum harmonic content
- Shared slots
- Symmetry among all coils
- Moderate end turn length
- A pitch to minimize 5th and 7th harmonics
- Tightly controlled coil geometry to minimize loose wires and high potential (voltage) crossovers
- Better placement of phase paper
- Reduced likelihood of buried coils.

These charts show the MMF patterns for a 36 slot, 4 pole winding. The 3 plots represent a two-layer concentric winding, a three-layer concentric winding, and a two-layer lap winding, span 1-8 (0.940 chord factor).

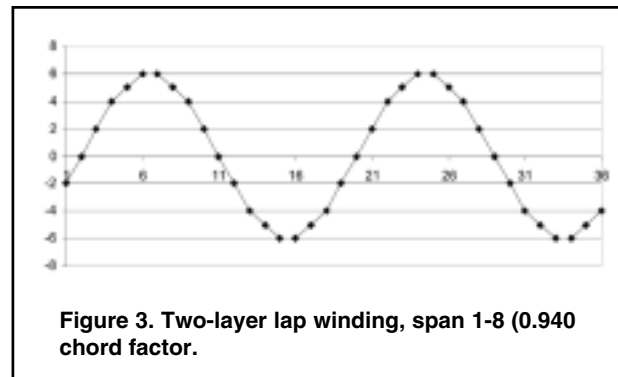
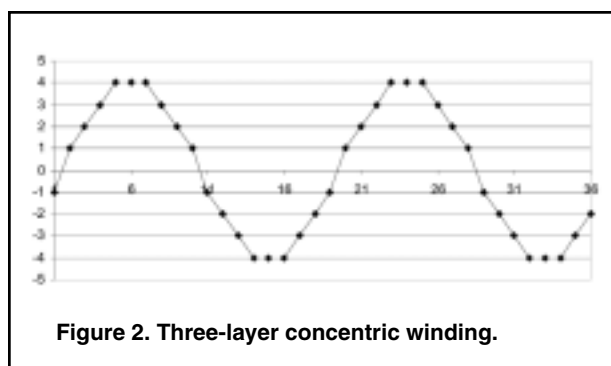
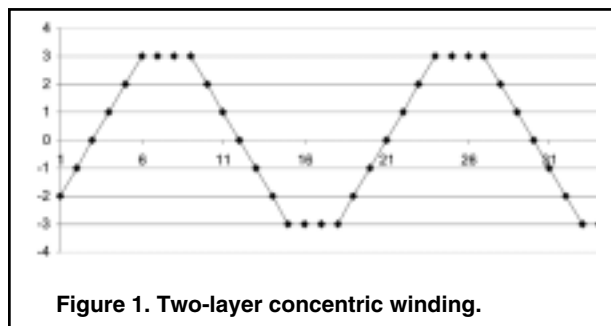

Appendix 3: Changing To Lap Windings—Examples

Common Changes to Winding Configuration: Concentric to Lap Winding

Use for: 4-pole and slower motors.

Use a double-layer, short-pitched lap winding (two coils per slot). The double-layer winding gives better results than a single-layer lap winding.

Recommendation: Use the optimal pitch ($83\% = 0.966$ chord factor) double-layer winding.

To optimize the efficiency of a lap winding:

- Use a double-layer lap winding. Calculate chord factor and turns/coil to keep flux constant.
- Do not change turns per coil without making corresponding change to chord factor.
- Use the same (preferably shorter) mean length of turn (MLT).
- Same (preferably larger) copper cross-sectional area.
- Same (preferably lower) winding resistance (temperature corrected).

Notes for short-pitched lap winding:

- Chord factor = $\text{Sin}[(8 \times 90^\circ)/9] = 0.985$, or $\text{Cos}[(1 \times 90/9] = 0.985$
- For constant flux, turns per coil increased $1/0.985$ or 1.5%.

Example 1: 2-layer concentric to double-layer lap conversion, winding short-pitched 1-9 (span 8)

A 36-slot, 4-pole motor has 18 coils with 24 turns per coil; coil pitch for each group is 1-8, 10, 12 (see Figure 1).

From Table 1, Appendix 1, the chord factor for each separate coil pitch is:

Coil pitch	K_p
1-8	.940
1-10	1.0
1-12	.940

To calculate effective turns per pole:

$(T/C_1 \times K_{p1}) + (T/C_2 \times K_{p2}) + (T/C_3 \times K_{p3}) \dots$ for a complete group of coils.

A suitable lap winding conversion would be calculated as follows:

24 turns per coil. Pitch: 1-8, 10, 12, resulting in chord factors of 0.940, 1.0 and 0.940, respectively.

$$24 (.940) + 24 (1.0) + 24 (.940) = 69.12 \text{ effective turns}$$

If a coil pitch of 1-9 (see Figure 2) is selected for the lap conversion:

$$69.12/3 = 23.04 \text{ effective turns per coil}$$

Actual turns per coil are calculated by dividing the effective turns per coil by ($k_p \times k_d$):

$$23.04/(\.985 \times .960) = 24.37 \text{ turns per slot}$$

Rounding down to 24 turns will result in a flux increase of 1%.

(Note: When a concentric winding has only 1 coil side per slot, and the replacement lap winding has 2 coil sides per slot, divide the turns per slot value by 2 to obtain the turns per coil.)

Depending on the coil pitch selected for the lap winding, the turns per slot for the lap winding might be fewer than, equal to, or greater than the number of turns per slot for the original concentric design.

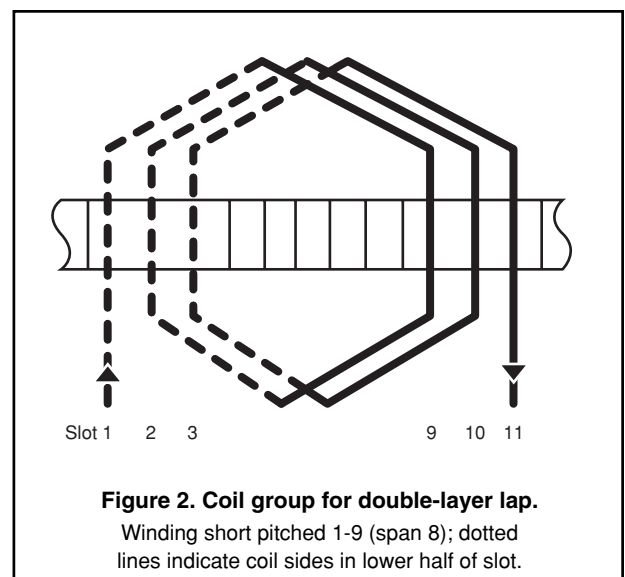
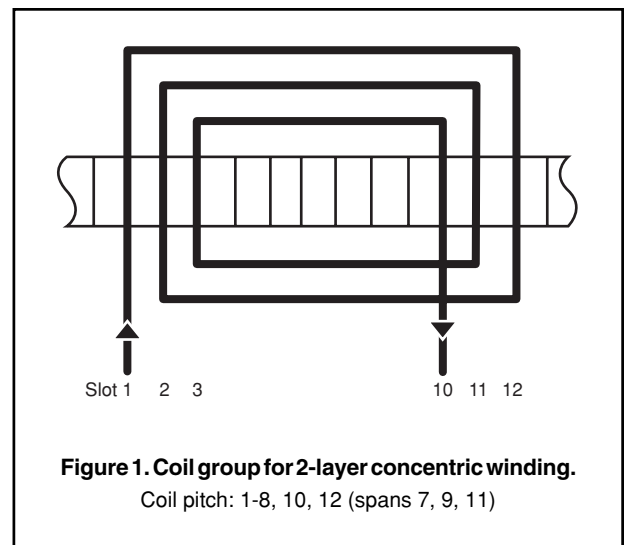

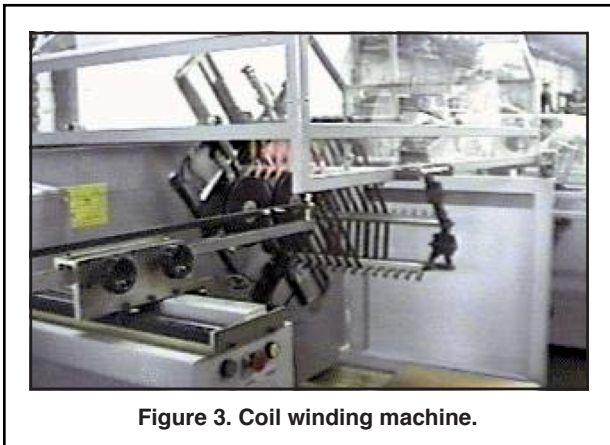

Figure 3. Coil winding machine.

Example 2: Double-layer concentric to conventional double-layer lap winding conversion

Use for: Larger motors with 2 or more poles if repairer does not want to copy the original concentric winding.

Advantages

- Mean length of turn (MLT) can be made the same as that of the original winding (possibly shorter) on a coil group basis.
- **Efficiency can be maintained or improved.**
- All coils are the same.

Caution

- Care needed to calculate pitch of new winding correctly.

Example: Change a 4-pole, 72 slot stator having 12 coil groups with 6 coils per group and 15 turns per coil to a 72-slot, 2-layer winding with optimal pitch.

The concentric winding (Figure 4) would typically be pitched:

1-11 (span 10)	1-17 (span 16)
1-13 (span 12)	1-19 (span 18)
1-15 (span 14)	1-21 (span 20)

Average coil pitch = 1-16 (span 15)

Pole pitch is $72/4 = 1-19$ (span 18)

If the same turns and wire size are used, efficiency will be maintained with a conventional double-layer lap winding pitched 1-16 (span 15).

$$83.13/6 = 13.86 \text{ Effective turns per coil}$$

$$\frac{13.86}{.966 \times .956} = 15.01 \text{ Use 15 turns per coil; pitch of 1-16 (see Figure 5).}$$

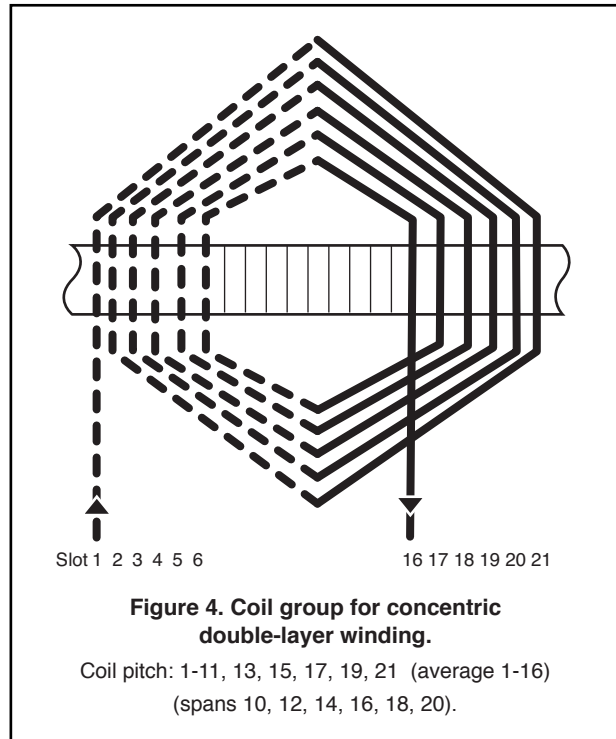

Figure 4. Coil group for concentric double-layer winding.

Coil pitch: 1-11, 13, 15, 17, 19, 21 (average 1-16) (spans 10, 12, 14, 16, 18, 20).

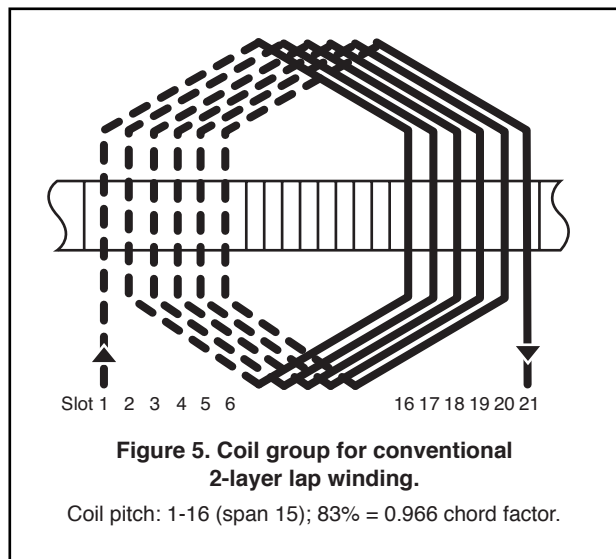

Figure 5. Coil group for conventional 2-layer lap winding.

Coil pitch: 1-16 (span 15); 83% = 0.966 chord factor.

Calculation for effective turns/pole	Coil pitch	K_p	Effective turns/coil
15 turns/coil	1-11 (span 10)	.766	11.49
	1-13 (span 12)	.866	12.99
	1-15 (span 14)	.940	14.1
	1-17 (span 16)	.985	14.775
	1-19 (span 18)	1.0	15
	1-21 (span 20)	.985	14.775
Effective turns/pole =			83.13

Appendix 4: Electrical Steels

1 World Standards

Most electrical steels are designated according to their guaranteed maximum specific total loss at a peak magnetization of 1.5 or 1.7 Tesla (97 or 110 kl/in²) and at a specified frequency (60 Hz for US standards, 50 Hz for most others). Principal standardization bodies include:

- ASTM - American Society for Testing and Materials
- AISI - American Iron & Steel Institute
- BS - British Standards
- DIN - Deutsches Institut für Normung (Germany)
- EN - European Standards
- GOST R - National Standard of the Russian Federation
- IEC - International Electrotechnical Commission
- JIS - Japanese Industrial Standards

In Europe, national standards (e.g., BS, DIN, etc.) are being replaced by European Standards (ENs). Close working relationships between the European standards bodies (CEN and CENELEC) and the International standards body (IEC) are resulting in increasing convergence between EN and IEC Standards. American standards, however, remain different, principally in terms of dimensions, units and reference frequency. Nevertheless, the underlying physical and electromagnetic principles which govern the performance of electrical steels are the same on both sides of the Atlantic. This section describes those principles, with particular attention to the repair industry, and also compares European and US practice.

2 General Classes of Electrical Steel

In practice, electrical steels are divided into two main classes with several subdivisions. These have been established by common acceptance in the industry, and are so universally used that an understanding of them is necessary. They are based on the primary magnetic property of the material, the form, the difference from other grades, or the method by which the material is produced. The two main classes are:

- Grain-oriented steels
- Non-oriented steels

2.1 Grain-oriented steels

This term describes electrical steels that possess magnetic properties which are strongly oriented with respect to the direction of rolling. By a process of rolling and annealing, alloys of suitable composition can be produced with a metallic crystal structure in which the grains are aligned so that magnetic properties are vastly superior in the direction of rolling. This results in inferior properties in other directions, however. They are used mainly for transformer cores and in large, low-speed synchronous machines which have cores fabricated from many steel sections. Grain-oriented electrical steels are outside the scope of the EASA/AEMT rewind study.

2.2 Non-oriented steels

This class of electrical steels has practically the same magnetic properties in any direction of magnetization in the plane of the material. The term “non-oriented” differentiates these materials from those produced by processes that create a definite orientation or directionality of magnetic properties. They are the steels which form the cores of the vast majority of industrial electric motors and generators. Non-oriented steels may be further subdivided into two groups based on their method of manufacture:

- Fully processed
- Semi-processed

2.2.1 Fully-processed steels

These are electrical steels in which the magnetic properties are completely developed by the steel producer. The name is derived from the fact that the materials are completely processed, ready for use, without any additional processing required to achieve the desired magnetic quality. A low-temperature heat treatment may be employed by the user to eliminate stresses introduced by fabrication of the material into cores. However, care is needed because some of the organic varnishes used to insulate the coreplates have very limited temperature withstand capabilities (see section 4.6.1).

2.2.2 Semi-processed steels

These electrical steels are finished to final thickness and physical form (sheets or coils) by the producer but are not fully annealed to develop final magnetic quality. With these materials, the user (i.e., the motor manufacturer) is responsible for achieving the magnetic properties by the annealing treatment. The final annealing process takes place after the laminations have been punched. The temperature and time required depends on the type of steel being used.

3 Electrical Steel Characteristics

Three main characteristics of electrical steels are important to their use in electrical machines:

- **Steel loss**—watts/lb (watts/kg) at a given peak flux density “B”. Tables 1, 2 and 3 show the maximum values for this loss, in US (ASTM) and International (IEC) standards. Note that the average loss for any particular steel grade is normally significantly lower (10 - 25%) than the maximum in the standard.
- **Permeability**—determines the flux density that the laminations can handle without saturating and relates this to the magnetizing force required to produce that flux density.
- **Thermal conductivity**—influences how well the steel dissipates heat losses generated within it.

Each of these characteristics is discussed in more detail in the following paragraphs.

**TABLE 1. MAXIMUM CORE LOSSES FOR
NON-ORIENTED FULLY-PROCESSED SILICON ALLOY ELECTRICAL STEELS**

Standard			Thickness (gage)		Max core loss @ 1.5 Tesla (15 kG)	
ASTM A677 1996	Old AISI grade	IEC 60404-8-4 1986*	inch	mm	W/lb 60 Hz	W/kg 50 Hz
		270-50A5	0.0197	0.50	1.66	2.90
47F168	M-15		0.0185	0.47	1.68	2.93
47F174	M-19		0.0185	0.47	1.74	3.03
		310-50A5	0.0197	0.50	1.78	3.10
47F185	M-22		0.0185	0.47	1.85	3.22
		330-50A5	0.0197	0.50	1.90	3.30
47F190	M-27		0.0185	0.47	1.90	3.31
		350-50A5	0.0197	0.50	2.01	3.50
47F205	M-36		0.0185	0.47	2.05	3.57
		400-50A5	0.0197	0.50	2.30	4.00
47F230	M-43		0.0185	0.47	2.30	4.01
		530-50A5	0.0197	0.50	3.04	5.30
47F305	M-45		0.0185	0.47	3.05	5.31
47F400	M-47		0.0185	0.47	4.00	6.98
		700-50A5	0.0197	0.50	4.02	7.00
		400-65A5	0.0256	0.65	2.25	3.92
64F270	M-43		0.0250	0.64	2.70	4.70
		530-65A5	0.0256	0.65	3.05	5.30
64F320	M-45		0.0250	0.64	3.20	5.57
		600-65A5	0.0256	0.65	3.45	6.00
64F360	M-45		0.0250	0.64	3.60	6.27
64F400			0.0250	0.64	4.00	6.96
		700-65A5	0.0256	0.65	4.02	7.00

**TABLE 2. MAXIMUM CORE LOSSES FOR
NON-ORIENTED SEMI-PROCESSED SILICON ALLOY ELECTRICAL STEELS**

Standard			Thickness (gage)		Max core loss @ 1.5 Tesla (15 kG)	
ASTM A683	Old AISI Grade	IEC 60401-8-2	inch	mm	Watts/lb 60Hz	Watts/kg 50Hz
47S178	M-27		0.0185	0.47	1.78	3.10
47S188	M-36		0.0185	0.47	1.88	3.27
		340-50-E5	0.0197	0.50	1.95	3.39
47S200	M-43		0.0185	0.47	2.00	3.48
		390-50-E5	0.0197	0.50	2.24	3.90
47S250	M-45		0.0185	0.47	2.50	4.35
		560-50-E5	0.0197	0.50	3.17	5.52
47S350			0.0185	0.47	3.50	6.10
64S230	M-43		0.0250	0.64	2.30	4.01
		390-65-E5	0.0256	0.65	2.30	4.01
		450-65-E5	0.0256	0.65	2.67	4.60
64S280	M-45		0.0250	0.64	2.80	4.88
		520-65-E5	0.0256	0.65	3.03	5.28
		630-65-E5	0.0256	0.65	3.61	6.29
64S420			0.0256	0.64	4.20	7.31

**TABLE 3. MAXIMUM CORE LOSSES FOR
NON-ORIENTED, SEMI-PROCESSED, NON-ALLOYED ELECTRICAL STEELS**

Standard			Thickness (gage)		Max core loss @ 1.5 Tesla (15 kG)	
ASTM	Old AISI	IEC 60404-8-2	inch	mm	Watts/lb 60 Hz	Watts/kg 50 Hz
		420-50-D5*	0.0197	0.50	2.41	4.19
		660-50-D5	0.0197	0.50	3.78	6.58
		890-50-D5	0.0197	0.50	5.10	8.88
		570-65-D5*	0.0256	0.65	3.27	5.69
		800-65-D5	0.0256	0.65	4.59	7.98
		1000-65-D5	0.0256	0.65	5.74	9.98

*These designations refer to "Polycor" steels manufactured by Cogent Power in Europe. They are not standardized grades in the IEC, EN or BS system of reference grades.

3.1 Steel losses

The main components of steel loss in an electrical machine are:

- Hysteresis loss
- Eddy current loss
- Interlaminar loss
- Rotational loss
- Air gap surface loss (usually considered part of stray loss)

Hysteresis and eddy current losses are properties of the steel itself; the remainder relate to the way it is used in the core of an electrical machine. All these losses increase with supply frequency, but all except the air gap surface loss are independent of machine load.

3.1.1 Hysteresis loss

The flux produced in a magnetic core material differs depending upon whether the magnetizing force causing the flux change is increasing or decreasing. This difference is caused by a phenomenon known as hysteresis. The expenditure of energy associated with this difference is known as the hysteresis loss. This loss is manifested as internal heat in the core material. Hysteresis loss increases rapidly with increasing flux density and with the frequency of alternation of magnetization (i.e., supply frequency).

3.1.2 Eddy current loss

Electrical currents flowing in the conductors surrounding a magnetic core induce magnetic flux in the core material. If the induced magnetic flux is varied, it in turn induces voltages in any conducting path which surrounds or links the flux lines. Some of these conducting paths lie inside the core structure. Voltages along these paths produce circulating currents inside the core material. These currents are known as eddy currents.

The magnitude of the eddy currents depends upon the supply frequency, the density of the magnetic flux, and upon the specific resistance and thickness of the core material.

If a magnetic core were made of one thick piece of material, the eddy currents would not be restricted, resulting in a high energy loss. This loss would be manifested as heat,

which would increase the temperature of the core very considerably. Since the early days of electrical machine design, this loss of useful energy in the core has been markedly reduced by manufacturing cores with many layers or laminations of core steel. The laminations restrict the eddy current paths, greatly reducing eddy current losses; the thinner the laminations, the lower the loss. For this reason, flat-rolled electrical steel is used to produce laminations which, when stacked and suitably assembled, become the magnetic cores of many electrical devices.

3.1.3 Interlaminar loss

In addition to the eddy current loss which occurs within each lamination, a further expenditure of power, known as interlaminar loss, will be present unless the laminations are completely insulated from one another. The amount of insulation necessary to keep this component of loss negligible varies with the size of the magnetic core, the mechanical pressure applied to the core, the flux density and the frequency. Excessive burrs on the edge of the laminations will increase the interlaminar losses. Machine repairers can thus increase this loss very considerably by such practices as filing stator slots. It can also be increased by applying too much axial pressure to a core when it is rebuilt after the laminations have been re-insulated.

3.1.4 Rotational loss

Rotational loss is a specific form of eddy current loss caused by excessive radial pressure on the stator core. It is of particular importance in induction machines with distributed stator windings. If the radial pressure on the stator core is excessive, localized circular eddy currents flow in each lamination at the top of each stator tooth that can significantly increase the stator iron loss. Therefore, when fitting a new frame repairers should ensure that the interference fit between the new frame and the core is not greater than that between the old frame and the core.

3.1.5 Air gap surface loss

The air gap surface loss in induction motors is caused by eddy currents in the stator and rotor teeth as they pass each other at slip speed. These are high-frequency currents, the frequency of which depends on the slip speed and the

number of stator and rotor teeth. Their magnitude increases with motor load and can result in the apparent iron loss at full load being considerably higher than the machine iron loss measured at no load.

3.2 Permeability

When a magnetizing force is applied across an air space, a magnetic field is produced. If the air space is filled with a ferromagnetic material and the same magnetizing force is maintained, a large increase in magnetic flux will result. Dividing the flux developed in the ferromagnetic material by the flux developed in the same air space gives a ratio which is called the permeability of the ferromagnetic material.

For ferromagnetic materials, permeability is not a constant—it varies with the applied magnetizing force and the flux density. As the magnetizing force is increased linearly, the flux density in the steel rises slowly at first, then much more quickly, then progressively more slowly as the flux saturates the steel. As the magnetizing force is reduced and reversed, the flux reduces but not along the same path as it increased. Thus a single cyclical reversal of the magnetizing force will result in a flux density/magnetizing force graph that forms a “loop” (often called the hysteresis loop for the material). The area within the loop is proportional to the hysteresis loss in the steel. Figure 1 shows a range of hysteresis loops for different types of steel and indicates that electrical steels give a good compromise of high flux density for reasonably low magnetizing force.

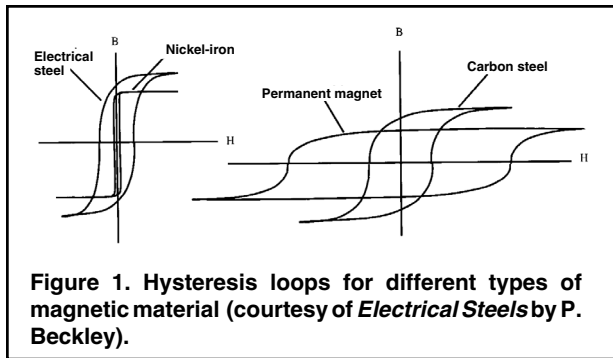

Figure 1. Hysteresis loops for different types of magnetic material (courtesy of *Electrical Steels* by P. Beckley).

3.3 Thermal conductivity

Good thermal conductivity in electrical steel is important because the losses in the steel generate heat which has to be conducted to those parts of the core in contact with the cooling medium—usually air. Thermal conductivity is not easy to measure, but it is closely linked to electrical conductivity. The ratio of thermal conductivity to electrical conductivity is approximately constant (a ratio of about 3).

$$\frac{\text{Thermal conductivity}}{\text{Electrical conductivity}} \approx 3 \text{ (constant)*}$$

*for a consistent number of units, e.g.:

Electrical conductivity = mhos (reciprocal ohms)

Thermal conductivity = watts/mKelvin (W/mK)

Thus measuring the resistivity [1/(conductivity)] of steel will give a good guide to its thermal conductivity. The bulk

resistivity of steel follows closely the percent of silicon present (see Figure 3). Note that low- or non-silicon steels have lower resistivities than those with higher percentages of silicon. Translating these into thermal conductivities for typical electrical steels gives the following:

1) Parallel to plane of lamination.

Grain oriented steel	27 W/mK
1.3% silicon steel	45 W/mK
Non-silicon steel	66 W/mK

2) Perpendicular to the plane of lamination (i.e., across length of lamination stack), thermal impedance reduces the values to 2 - 3% of those in the parallel direction. See Figure 2.

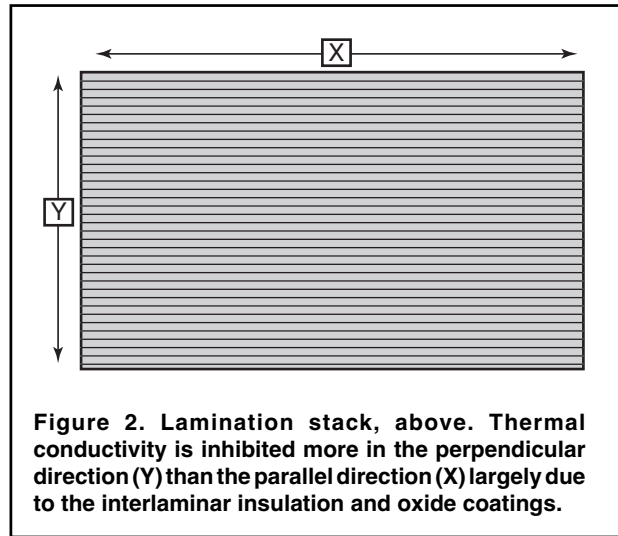

Figure 2. Lamination stack, above. Thermal conductivity is inhibited more in the perpendicular direction (Y) than the parallel direction (X) largely due to the interlaminar insulation and oxide coatings.

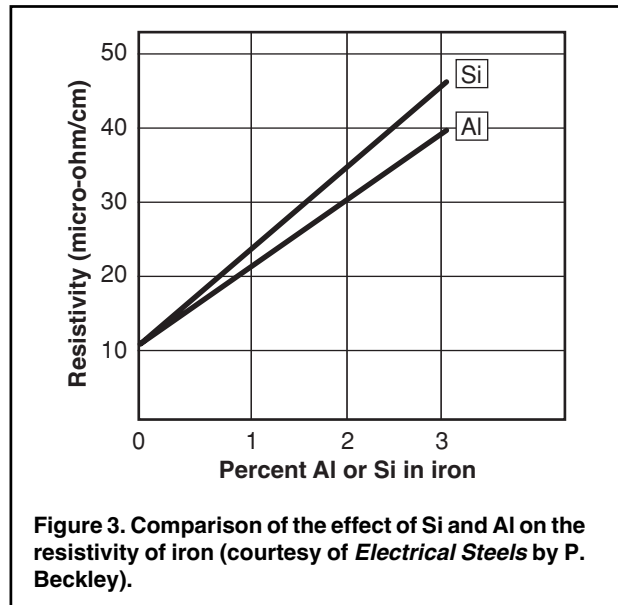

Figure 3. Comparison of the effect of Si and Al on the resistivity of iron (courtesy of *Electrical Steels* by P. Beckley).

3.4 The “ideal” steel for an electrical machine

From a machine designer’s viewpoint, the ideal steel for an electrical machine would be one which has low loss, high permeability and high conductivity. Unfortunately silicon,

the main alloying element used in electrical steels to reduce loss, also reduces permeability and conductivity and increases manufacturing cost. Electrical steel manufacturers have to compromise on both steel composition and manufacturing methods to produce a range of steels with different loss and permeability characteristics (for different types and qualities of machines) at acceptable costs.

In recent years considerable research has been undertaken to develop low-loss, low- or no-silicon steels with ultra-low carbon and ultra-low sulphur contents. Some steels of this type are already offered and further developments can be expected in the future.

4 Composition of Electrical Steels

Flat-rolled electrical steels are produced to meet magnetic property specifications rather than specific chemical composition. Magnetic characteristics are of first importance and depend on processing as well as on chemical composition.

Silicon is the primary alloying element in electrical steels. It is added because it increases the volume resistivity of the steel and thereby reduces the eddy current component of core loss. Silicon has an added benefit. It affects the grain structure of the steel and thus improves core loss somewhat by reducing the hysteresis component in non-oriented electrical steels.

Depending on the type of product, the other main alloying elements added to electrical steel are aluminum and manganese. Each of these is added for its metallurgical effect rather than for any physical effect such as volume resistivity. Each of them also favorably affects the grain structure of the steel, thereby helping to lower the hysteresis component of the core loss.

Other elements are present in electrical steels but are essentially impurities that are found only in residual amounts. Carbon is one element that changes in content from that present in the melt to that in the final product. Special heat treatments during mill processing lower the carbon content of the fully processed material to very low values. Carbon is removed from semi-processed grades by the customer (i.e., motor manufacturer) during annealing. In the case of grain-oriented steels, impurities such as sulphur and nitrogen are required initially to help develop the final crystal orientation, but these elements are then removed in the final anneal.

Since the magnetic quality of electrical steel is a function of chemical analysis and of mill processing, there may be some overlapping of the grades. Core loss, however, will generally vary with silicon content, with greater silicon content producing a grade with improved core loss but reduced high-induction permeability.

5 Production of Electrical Steels

5.1 Production methods and major producers

Most of world's electrical steel is produced in integrated steel mills which start with raw materials such as iron ore, coal and limestone and end with a finished coil of electrical steel. A small minority of production is carried out in mini-mills which start with scrap steel rather than raw materials.

Major integrated producers include:

USA/Americas

- CAK (was Armco) US
- Inland (US)
- LTV (US)
- US Steel (US)
- Acesita (Brazil)

Europe

- Thyssen Krupp Stahl (Germany/Italy/France)
- Cogent Power (UK, Scandinavia)

Pacific Rim

- Kawasaki (Japan)
- Nippon Steel (Japan)
- Pohang Steel (Korea)

5.2 Production processes that affect losses

Many steel production processes have some effect on steel losses, but apart from alloying the most important ones are:

- Annealing
- Surface coating or insulation
- Lamination thickness (gage)

5.2.1 Annealing

Manufacturers of electrical steels regulate their mill processes to produce a steel which has inherently good magnetic properties that will satisfy the specific requirements for the grade and type of steel being produced. However, the optimum benefits from those properties may not be realized in the finished electrical device if their customer (i.e., the motor manufacturer) does not fully recognize the need to control some possibly damaging factors. These include handling stresses, slitter distortions, punching distortions, edge burr, incomplete decarburization during lamination anneal, and overoxidation, to name a few. It is important to know that the best magnetic quality is associated with properly annealed cores or laminations that are free of stress, and thoroughly decarburized but not overoxidized. Freedom from stress in the assembled core is also essential.

Customer annealing usually falls into one of two broad classifications. A "stress-relief anneal" signifies a heat treatment that is normally used to restore the magnetic properties of fully processed grades. A "quality evaluation anneal" not only alleviates any stress conditions that exist in the lamination but also decarburizes and promotes grain growth.

The general purposes of annealing laminations and cores for the three general classes of electrical steels are shown in Table 4.

Both stress-relief and quality-evaluation annealing are most frequently done by continuous methods. The continuous annealing furnaces are specially adapted to high volume production and are provided with appropriate controlled gas atmospheres that protect the steel from damaging oxidation

TABLE 4. PURPOSE AND TYPES OF ANNEAL FOR ELECTRICAL STEELS

Steel Class	Anneal Practice	Primary Purpose of Anneal
Grain oriented	Stress relief	Relief of stresses developed during handling, slitting, forming, or punching. Oriented steel must be carefully protected from oxidizing or carburizing conditions which can severely impair magnetic quality.
Non-oriented fully processed	Stress relief	Relief of stress that has occurred as a result of mill and consumer processing operations. Insulating oxide development is sometimes desired.
Non-oriented semi-processed and non-oriented full hard	Quality evaluation	Develop magnetic quality by means of proper decarburization and grain growth. Form an insulating surface oxide.

while accomplishing the task of developing the desired magnetic characteristics. Continuous furnaces usually consist of: 1) a section for burning off punching lubricants; 2) high-heat zones for decarburization and grain growth; and 3) cooling sections which may also have provision for forming an insulating surface oxide.

5.2.2 Surface insulation of core materials

Limitation of eddy current losses to appropriate values requires electrical steel with adequate resistivity, sufficiently thin laminations, and effective electrical insulation of laminations. Eddy currents will flow not only within single laminations, but also within the core as a unit, across the lamination surfaces. Simply laminating a magnetic core will not prevent excessive currents from circulating within the entire core unless the surfaces of the laminations are adequately insulated and burrs are small.

The resistance of lamination surface insulation can be considered quite adequate when the interlaminar power loss is limited to a small fraction (usually about 1 or 2%) of the total core loss. What magnitude of insulation is adequate and which of the many available surface insulations should be used are somewhat complex questions. Their answers depend not only on the desired efficiency of the apparatus,

TABLE 5. DESCRIPTIONS OF FLAT ROLLED ELECTRICAL STEEL INSULATIONS OR COREPLATES (AISI CLASSIFICATION)

Identification	Description
C-0	This identification is merely for the purpose of describing the natural oxide surface which occurs on flat-rolled silicon steel which give a slight but effective insulating layer sufficient for most small cores and will withstand normal stress-relief annealing temperatures. This oxidized surface condition may be enhanced in the stress-relief anneal of finished cores by controlling the atmosphere to be more or less oxidizing to the surface.
C-2	This identification describes an inorganic insulation which consists of glass-like film which forms during high-temperature hydrogen anneal of grain-oriented silicon steel as the result of the reaction of an applied coating of MgO and silicates in the surface of the steel. This insulation is intended for air-cooled or oil-immersed cores. It will withstand stress-relief annealing temperatures and has sufficient interlamination resistance for wound cores of narrow width strip such as used in distribution transformer cores. It is not intended for stamped laminations because of the abrasive nature of the coating.
C-3	This insulation consists of an enamel or varnish coating intended for air-cooled or oil-immersed cores. The interlamination resistance provided by this coating is superior to the C-1 coating which is primarily utilized as a die lubricant. The C-3 coating also will enhance "punchability" and resist normal operating temperatures but will not withstand stress-relief annealing (see note*).
C-4	This insulation consists of a chemically treated or phosphated surface intended for air-cooled or oil-immersed cores requiring moderate levels of insulation resistance. It will withstand stress-relief annealing and promotes "punchability."
C-5	This is an inorganic insulation similar to C-4 but with ceramic fillers added to enhance the interlamination resistance. It is typically applied over the C-2 coating in grain-oriented silicon steel. It is principally intended for air-cooled or oil-immersed cores which utilize sheared laminations and operate at high volts per turn; it also finds application in all apparatus requiring high levels of interlaminar resistance. Like C-2, it will withstand stress-relief annealing in a neutral or slightly reducing atmosphere.

Note: In fabricating operations involving the application of heat, such as welding and die casting, it may be desirable to use a thinner than normal coating to leave as little residue as possible. These coatings can enhance "punchability," and the producers should be consulted to obtain a correct weight of coating. To identify these coatings, various letter suffixes have been adopted, and the producer should be consulted for the proper suffix.

*C-1 has been deleted from this table and is generally superseded by C-3.

but also upon a number of design and fabrication factors, each of which affects the magnitude of the interlaminar power loss.

Small electrical apparatus, such as fractional horsepower motors, may not require surface insulation beyond that provided by the natural oxide film produced in processing core steel or in stress relief annealing. But insulation may be needed for other reasons—e.g., in apparatus where the core may be subjected to corrosive environments, coreplate coating may be desirable to prevent deterioration of the limited resistance provided by the oxide film.

Coreplate coatings are also used in some cases primarily because they improve “punchability” of the steel. Their use can be justified because they increase die life and reduce punching costs.

An anti-stick coating available on semi-processed non-oriented electrical steels reduces lamination sticking. Coating improvements enable laminations to be annealed at higher temperatures than ordinary anti-stick coatings, resulting in increased productivity or in improved magnetic quality.

The type of coating used on the laminations is important to repairers because different coatings have different degrees of resistance to heat treatment—e.g., burnout prior to rewind.

5.2.3 Lamination thickness

Eddy current losses increase almost linearly as lamination thickness (gage) increases. It is sometimes said that for a given grade of steel the loss doubles as the thickness doubles, but this is an over simplification. Figure 4 illustrates the impact on the eddy current losses with varying thickness of the steel laminations.

In theory, for a given steel grade induced voltage increases in proportion to the cross sectional area—i.e., in proportion to the thickness for a given lamination shape.

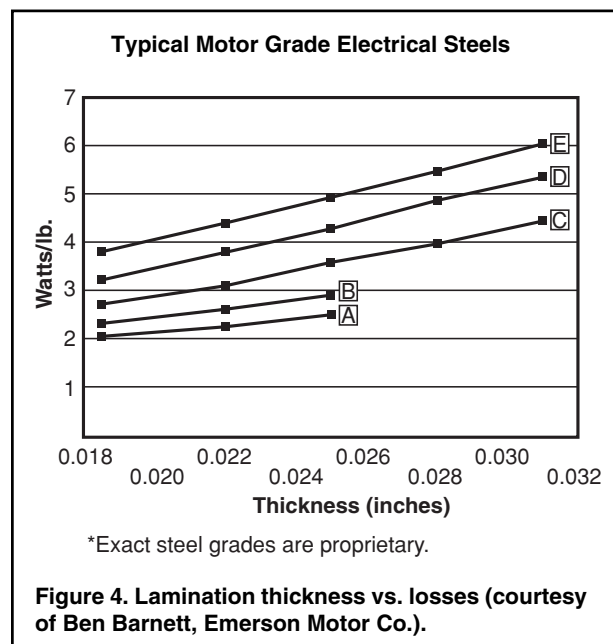

“Edge effects” caused by punching, however, and other factors mean that the eddy currents resulting from the induced voltages in the steel do not necessarily follow the same “square law” pattern. However, the “doubling approximation” is probably good enough for most practical purposes.

Theoretically, the thinner the laminations the better. In practice however, thinner laminations cost more both for the steel maker and the motor manufacturer. Laminations thinner than 0.0197” (0.5mm) become difficult to handle and more prone to damage during lamination and core manufacture. For this reason, very few industrial motors have laminations thinner than this, although thinner materials are used in high-frequency and other special purpose machines.

From the repairer’s viewpoint, the thinner the laminations, the more care is needed when removing old windings. This is particularly true with cores which are manufactured without finger plates.

In the US, motors typically use a lamination thickness between 0.0185” and 0.025” (0.47 - 0.64mm), but this will vary from one manufacturer to another. In Europe, the two most commonly used lamination thicknesses for both fractional and integral horsepower motors are 0.5mm and 0.65mm (0.0197 - 0.0296”). Table 6 shows the standard lamination thicknesses for induction machines.

Changing steel thickness is a major cost to motor manufacturers. Punching dies are normally optimized to one lamination thickness, so they must be replaced if the lamination thickness changes. It is particularly expensive on progression tools. Using punching dies not optimized to the material thickness will adversely affect burr height and may cause dies to stick or break during punching. Most motor or lamination manufacturers standardize on a single lamination thickness for any particular lamination diameter.

6 Conclusions

Developments in electrical steels and in the motor designer’s ability to make best use of them has resulted in a marked increase in the power-to-weight ratio (more than

TABLE 6. ELECTRICAL STEEL STANDARD THICKNESS (GAGE)

Territory	Thickness (gage) inch	mm	Electrical steel std. gage no.
Europe		0.27	
Europe		0.30	
Europe		0.35	
USA	0.0170	0.43	27
USA	0.0185	0.47	26
Europe	0.0197	0.50	
USA	0.0220	0.56	25
USA	0.0250	0.64	24
Europe	0.0256	0.65	
USA	0.0280	0.72	23
USA	0.0310	0.79	22

tenfold) for electrical machines over the last hundred years. However, the basic machine configurations have not changed fundamentally, and laminated steels still form the basis of most machine cores. Radical change is unlikely any time soon, but over time new materials and new design techniques may well alter the way future generations construct electrical machines.

The main driver will continue to be minimum cost, but increasingly environmental pressures are pointing the way to new kinds of low-loss materials. These include:

- **Cobalt irons.** The saturation induction of these materials is considerably increased and with 25% cobalt can be as high as 158 kI/in² (2.45 Tesla). They are very expensive, however, and are only used at present in applications where minimum weight is the dominant factor (e.g., machines for aerospace).
- **Amorphous metals.** These materials can be produced in very thin strips by very rapid cooling (e.g., 1 million degrees per second or more). Solidification is achieved without crystallization and at present commercial strips are available up to 1.2" (30 cm) wide. The material, which has losses of only 1/3 that of grain-oriented steels, is being used in some transformers. It is very difficult to see how it could be applied successfully to a rotating machine.
- **Micro-crystalline alloys.** These are produced by the same melt-spinning techniques which are used to produce amorphous steel. In general the same comments

apply as far as their application in rotating machines is concerned.

- **Composite materials.** At least two manufacturers have developed methods for producing solid cores by aggregating and pressing together iron (or iron alloy) particles that are insulated from one another by a thin surface coating. The resulting composite cores, which largely restrain eddy currents, are particularly useful for machines operating at frequencies of 100 Hz and above. Although the peak flux density is lower than with electrical steel, the ability of the machine designer to think three-dimensionally and design cores where all the steel is used optimally can lead to some potentially useful new design concepts, particularly for small machines.
- **Super conductivity.** Super conductivity allows very large currents to be contained in the turns of super conducting solenoids. This technique can be used to produce very high fields such as those required in some types of medical scanners. Super conductivity for electrical machines is being researched actively, but its application to all but a few specialized machines is still some way off.

At present, all of these options are more expensive (some much more so) than conventional lamination steels. In addition, there is the cost both to steel producers and motor manufacturers of a radical change in design.

Appendix 5: Repair/Replace Considerations

INTRODUCTION

For general-purpose motors, there are many cases where replacing a failed one with a new energy efficient motor is the best choice. However, in some cases, the motor will fail again unless the root cause of failure is addressed through some modification to the motor or the system.

There are also many cases where repairing the existing motor is the best choice. This is especially true if an upgrade is required to address the cause of failure, or in some cases, where cost, availability or unique performance is an issue. The motor service center is in an excellent position to make these assessments.

Quite often when a motor fails, the procedure is to remove the damaged motor from service and replace it without a thorough evaluation of the “root cause” of the failure. Depending on the motor size and the amount of damage, the old motor may be repaired and placed into spares inventory or even scrapped.

The problem with this approach is that the replacement motor, whether new or rebuilt, may fail again for the same reason. If a root cause failure analysis is conducted, it is often possible to identify and correct the underlying cause. All that may be required is to modify the motor, driven equipment or system to extend the *mean time between failures* (MTBF) significantly.

In most cases, where a standard motor is no longer suitable for the application, the service center is able to

make the required modification faster than the motor manufacturer can produce a unique model.

The Electrical Apparatus Service Association (EASA) has established Recommended Practices for more than 2100 members around the world to assure that the repair process does not degrade the motor performance characteristics. Both this study and another recent study [Advanced Energy study] have found that the efficiency of a repaired motor can sometimes be enhanced when good practices are followed.

Criteria are presented to determine when the repair of the motor is not practical and may lead to reduced efficiency levels. In some cases, it is possible to improve the level of operating efficiency during the repair process.

Table 1 shows the possible efficiency improvements that can be made for a generation of T-frame motors produced during the 1970s and '80s. Not all motors offer this opportunity, but for those that do this option should be considered as a possible product improvement.

Repair-replace decision model

In the past, the decision whether to repair or replace an electric motor has been one of economics. Replacement of an older electric motor with a more efficient model often makes sense for a motor operating continuously. In most cases, however, the decision is more complex (see Figures 1

TABLE 1: EFFICIENCY IMPROVEMENTS FOR ONE GENERATION OF T-FRAME MOTOR

	Horsepower	Winding type	Space factor (%)*	Nameplate NNE (%)	Full-load efficiency (%)
Original pre-EPACT	25	Machine	43.0	88.5	88.7
Rewound pre-EPACT	25	Lap	62.0	90.2	90.8
EPACT reference	25			91.7	
Original pre-EPACT	50	Machine	46.0	91.7	91.6
Rewound pre-EPACT	50	Lap	60.0	92.4	92.6
EPACT reference	50			93.0	

Typical 4-pole, open dripproof, general purpose, T-frame motors of pre-energy efficient design.

$$\text{*Percent space factor} = \frac{\text{Total number of wires per slot} \times \frac{3.14D^2}{4} \text{ of wire}}{\text{Total slot area} - \text{area of insulation}} \times 100$$

D = wire diameter

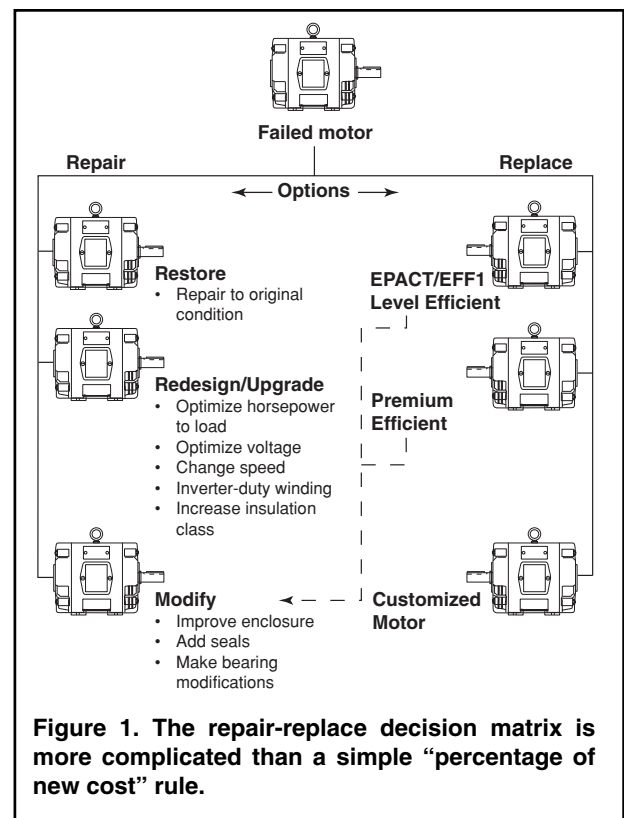
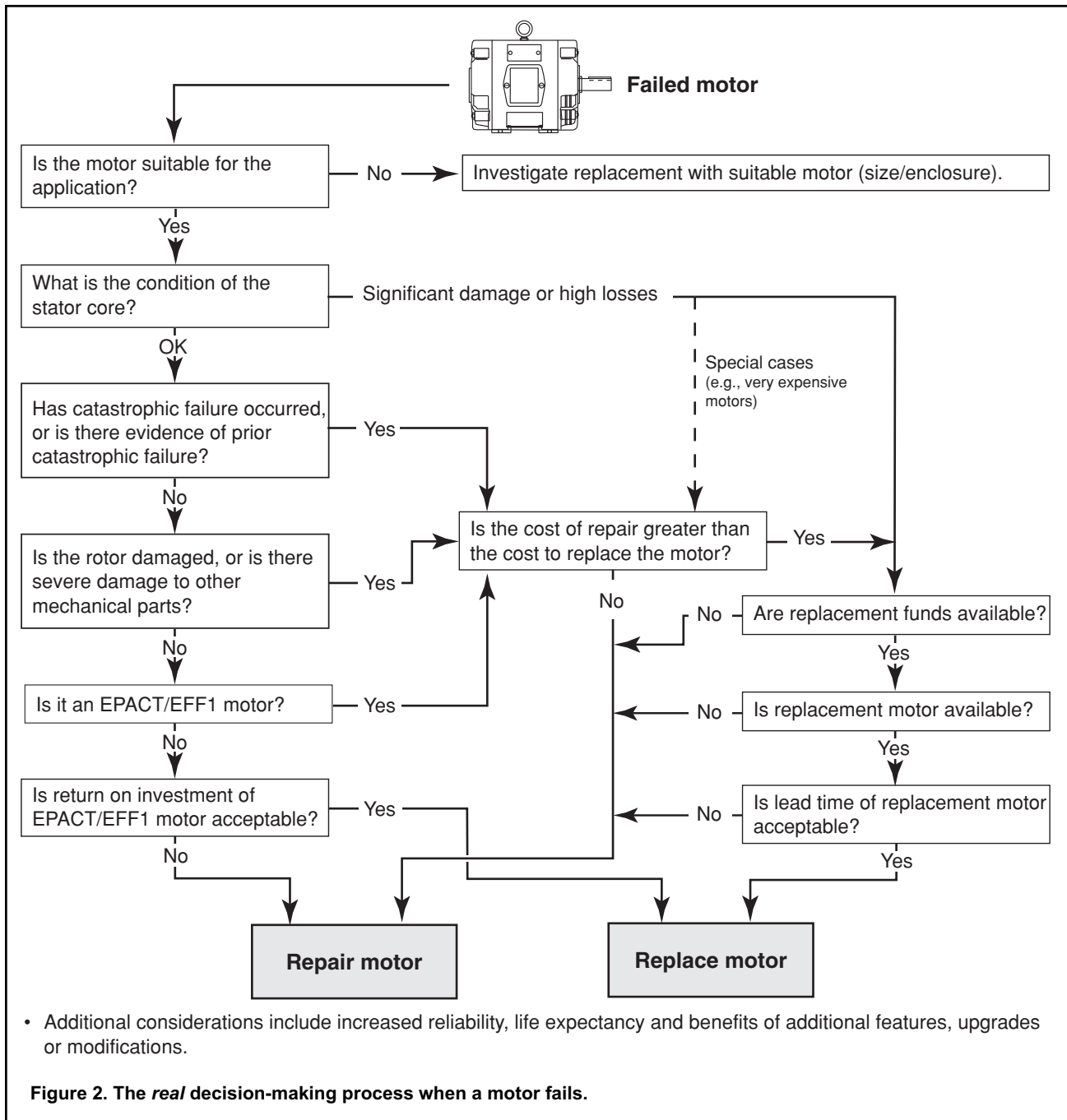

Figure 1. The repair-replace decision matrix is more complicated than a simple “percentage of new cost” rule.



and 2).

A motor operating infrequently, a motor with special mounting or design features, an EPACT/EFF1 motor or a motor larger than those covered by EPACT/EFF1 are all examples where the repair option may be the better choice.

When comparing the cost to replace or repair an electric motor, the equation should include not only operating cost and payback period, but also downtime and associated factors such as capital depreciation, and lost production. A misapplied replacement motor that fails within a year or two may have a significantly higher cost than a repair that optimizes the motor for its unique application.

Substantial annual energy savings are quickly wiped out by unscheduled downtime when a motor fails unexpectedly.

Much of today's literature emphasizes efficiency and the cost of energy as stand-alone factors in the repair-replace decision matrix. Frequently, the cost of the motor—or its repair—is a small fraction of the total cost of downtime *when lost production is factored in*.

Considerations (other than efficiency and simple payback) include reliability, performance and anticipated motor life, as well as availability of a replacement. Of these, the most critical may be reliability. A motor *customized* to its application will offer the greatest chance of long life. "Zero

UNUSUAL SERVICE CONDITIONS, NEMA MG 1-1998

14.3 UNUSUAL SERVICE CONDITIONS

The manufacturer should be consulted if any unusual service conditions exist which may affect the construction or operation of the motor. Among such conditions are:

- a. Exposure to:
 1. Combustible, explosive, abrasive, or conducting dusts
 2. Lint or very dirty operating conditions where the accumulation of dirt may interfere with normal ventilation
 3. Chemical fumes, flammable or explosive gases
 4. Nuclear radiation
 5. Steam, salt-laden air, or oil vapor
 6. Damp or very dry locations, radiant heat, vermin infestation, or atmospheres conducive to the growth of fungus
 7. Abnormal shock, vibration, or mechanical loading from external sources
 8. Abnormal axial or side thrust imposed on the motor shaft
- b. Operation where:
 1. There is excessive departure from rated voltage or frequency, or both
 2. The deviation factor of the alternating-current supply voltage exceeds 10 percent
 3. The alternating-current supply voltage is unbalanced by more than 1 percent

- 4. The rectifier output supplying a direct-current motor is unbalanced so that the difference between the highest and lowest peak amplitudes of the current pulses over one cycle exceed 10 percent of the highest pulse amplitude at rated armature current
- 5. Low noise levels are required
- 6. The power system is not grounded
- c. Operation at speeds above the highest rated speed
- d. Operation in a poorly ventilated room, in a pit, or in an inclined position
- e. Operation where subjected to:
 1. Torsional impact loads
 2. Repetitive abnormal overloads
 3. Reversing or electric braking
 4. Frequent starting
 5. Out-of-phase bus transfer
 6. Frequent short circuits
- f. Operation of machine at standstill with any winding continuously energized or of short-time-rated machine with any winding continuously energized
- g. Operation of direct-current machine where the average armature current is less than 50 percent of the rated full-load amperes over a 24-hour period, or continuous operation at armature current less than 50 percent of rated current for more than 4 hours

Figure 3. Unusual service conditions.

downtime” is a noble goal, one that requires commitment and planning.

NEMA MG 1-1998 defines “Unusual Service Conditions” (see Figure 3). Most readers will recognize many of these as the norm for real-life motor applications. Of itself, this fact may be justification for repair and customization of a failed electric motor, rather than stock replacement.

It makes economic sense to identify the weak link in any

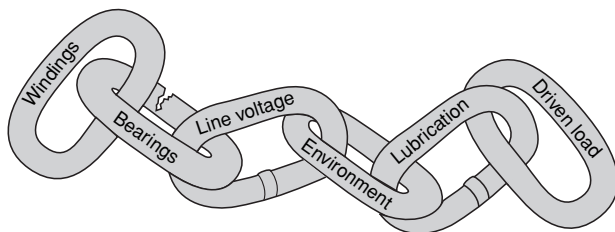

process, and to detect imminent failure before it occurs. Strengthening the weak link makes the entire process stronger. A motor subject to accidental wash-down should be of a suitable enclosure, and can be modified to further protect it from this hazard. Likewise, since more than 50% of electric motor failures start as bearing failures (Figure 4), bearing temperature detectors or vibration probes are logical options in many cases.

With today’s rapidly changing technology, the motor

manufacturer is hard-pressed to incorporate emerging technology within a two- to three-year period. One advantage the service center has is its ability to deal with each unique

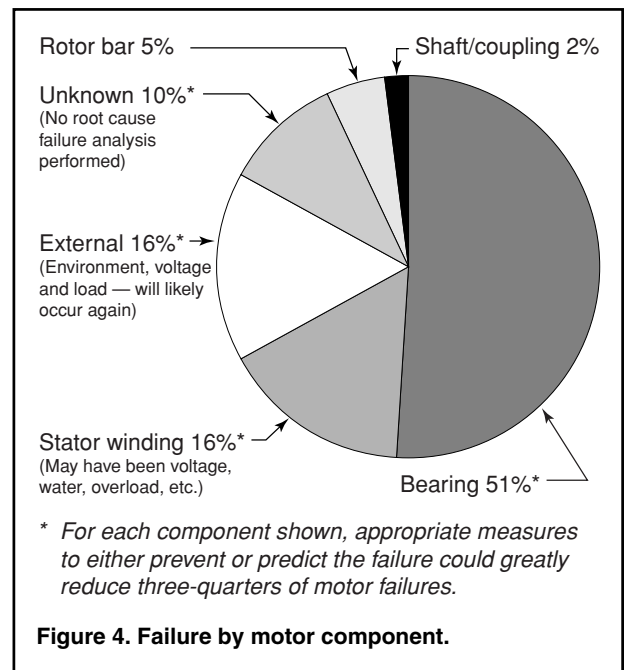

Figure 4. Failure by motor component.

motor and apply new technology *as it develops* to address specific concerns about that particular motor's application and environment.

This means the end users can take advantage of unique technology that meets their unique needs.

Whether the concern is winding temperature, vibration or bearing temperature, specific accessories can be incorporated into the repair process to enhance motor life and permit the end-user to monitor the critical feature.

Consider winding temperature alone: There are four different RTD resistances, 14 different thermocouples and

numerous thermistors and bimetallic switches in common use. Clearly, a stock motor cannot cover all these options. These features are a special order from motor manufacturers and usually require long lead times. The service center is able to tailor the motor repair to match the end user's monitoring equipment, incorporating special features without impacting the repair turnaround.

Vibration monitoring is available as a continuous, online system. Accelerometers are but one item that can be retrofitted to improve the user's ability to predict equipment failure. Non-contact shaft probes, accelerometers intended

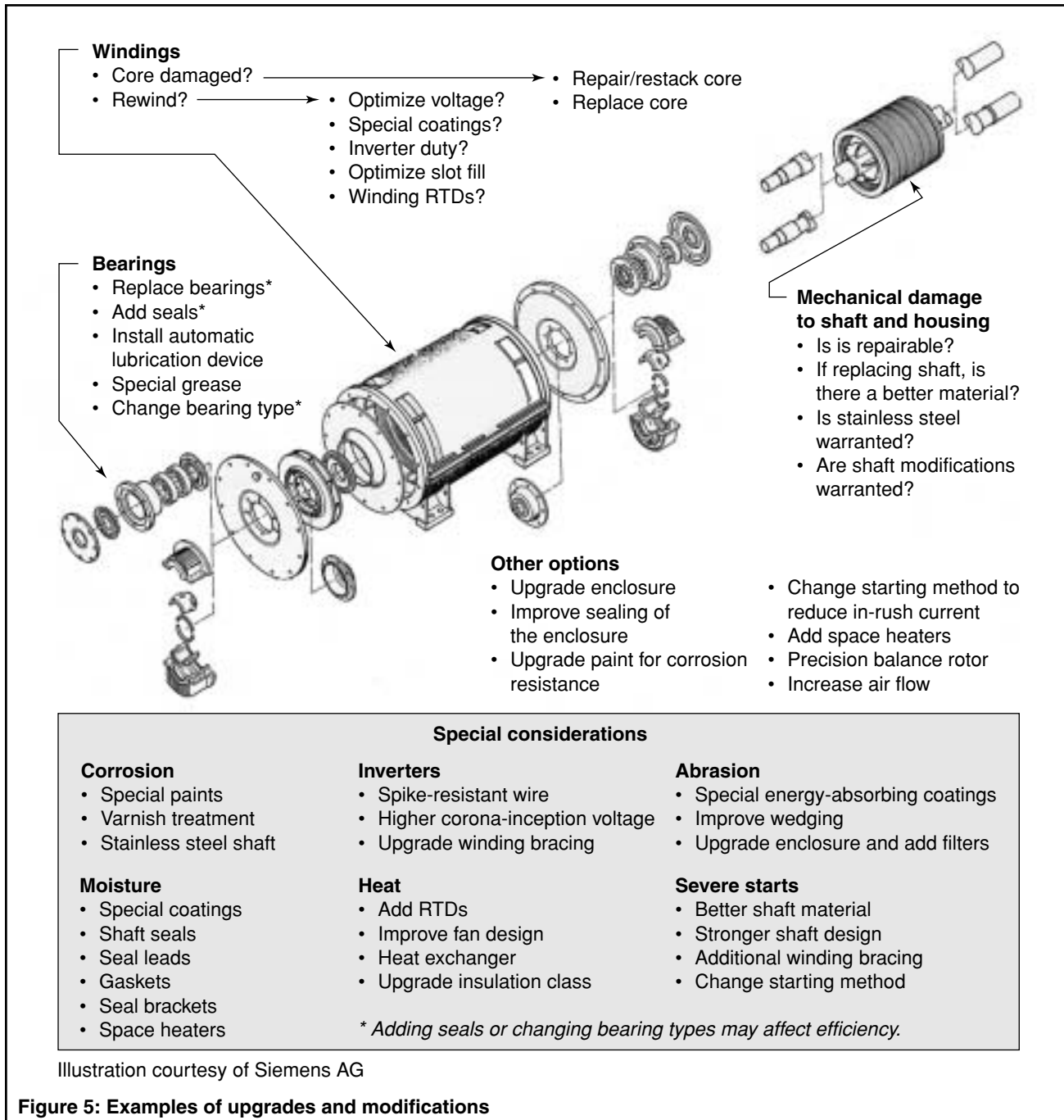

for continuous monitoring and periodic data collection, accelerometers integral to a sophisticated continuous monitoring system; all are available technology today. Once a user makes the financial commitment to a particular system, it is rarely practical to abandon it in favor of another emerging technology. That makes the service center a partner in maintaining the system(s) selected by each end user.

With most companies returning to their “core business,” and outsourcing maintenance, the competent service center is best qualified to assess the cause of each motor failure and develop a plan to reduce the possibility of a repeat failure. The service center warranty ensures the repairer has a vested interest in identifying the root cause of the motor failure, and performing a quality repair.

Examples of upgrades and modifications

Once a cause of failure is determined, the service center can work with the equipment owner to identify specific remedies to extend the mean time between failures (MTBF); see Figure 5. The following are but a few examples of frequent problems—and solutions—service centers encounter.

Voltage optimization

A municipal pump station is located at the end of the power transmission line. Motor failures are common, and winding temperatures are higher than those of identical motors operating at the water treatment plant in town. Repeated measurements have confirmed chronic low voltage.

When a winding failure is the result of low applied voltage, the replacement motor—regardless of efficiency—will be subject to the same low line voltage. The solution, then, is to redesign the motor to optimize performance at the actual applied voltage. It is common to apply a 230 volt motor to a 200 or 208 volt application.

Compounding the problem, the utility supplying 208 volts is allowed to deviate and may supply even lower voltage. Table 2 illustrates the effect on efficiency and winding temperature.

Low voltages are especially common in rural areas, where the motor may be operating at a considerable distance from the nearest substation. Irrigation pumps and municipal pump stations are two examples.

While many manufacturers can deliver a motor to optimize nonstandard line voltage, typical manufacturer lead times of five to eight weeks may be prohibitive. The service center can accomplish the same voltage optimization during a motor rewind.

An added benefit: It is common practice for manufacturers to produce motors with up to 12 leads, so that the motor may be used on multiple voltages, often as a part-winding start or wye-start, delta-run. This means the electrician may deal with many leads in the junction box, increasing the chances of a ground failure from abraded leads. When an electric motor is repaired, the service center has the option of installing only the number of leads required. With only 3 or 6 leads, there is more room in the junction box and less chance of lead damage or misconnection during installation.

TABLE 2: EFFICIENCY AND WINDING TEMPERATURE		
Volts	208	230
Efficiency (%)	80.6	84.4
Power factor (%)	85.0	82.7
Full load current (amps)	30.5	26.9
Inrush current (amps)	129	148
Temperature rise (° C)	91	72
Slip (%)	5.9	4.1
Design B, 4-pole, tri-voltage motor (208-230/460)		

Table 2. The effects of voltage variation on efficiency and winding temperature.

Note: Tri-voltage motors (208-230/460) represent a compromise between the possible applied voltages. This improves potential availability, to the detriment of efficiency at certain applied voltages.

In the European Union the standard three-phase voltage range is 380-420V. Most modern motors are designed for optimum performance at 400V, but many older motors will have been designed for 380V or 415V depending on their country of origin. Rewinding can be used as an opportunity to optimize the motor for the known voltage.

Energy Efficiency Improvement

There are occasions when rewinding a motor presents an opportunity to enhance motor performance and reliability by modifying the winding configuration and copper content. For many designs, the I²R loss is the largest loss component (Figure 6). Sometimes, this loss can be reduced by converting from a machine-wound configuration to a traditional,

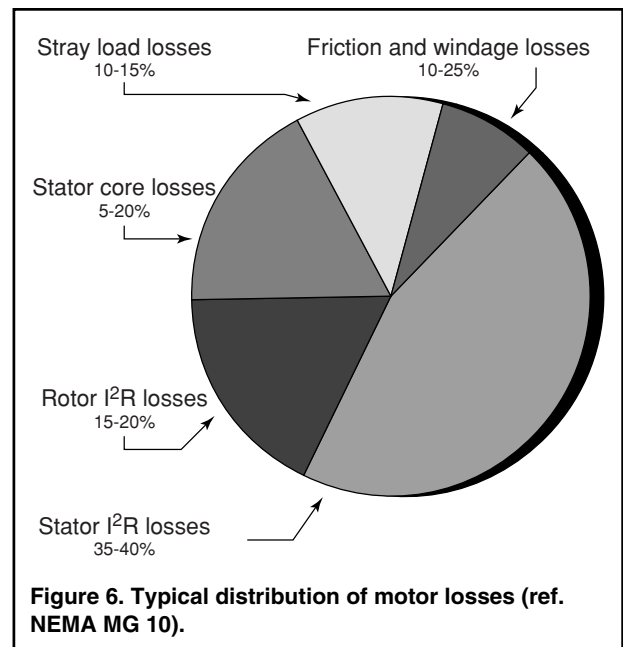

Figure 6. Typical distribution of motor losses (ref. NEMA MG 10).

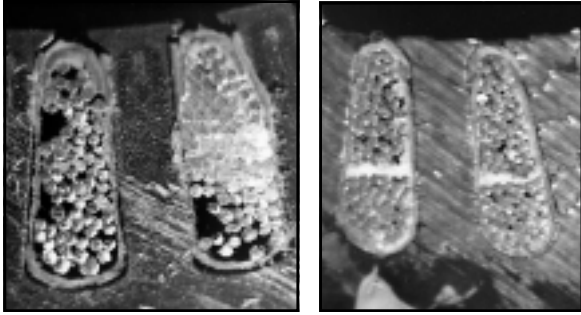

Figure 7. Increase slot fill from low (left) to the higher slot fill on the right. An increase in copper area reduces I²R losses.

hand-inserted winding. In many cases, the copper content (slot fill) can also be increased. Figure 7 compares a stator that has a relatively low slot fill (40 to 50%) and one with a much greater percentage of slot fill (60 to 64%).

This modification will improve heat transfer, reduce the I²R loss and winding temperature and improve motor efficiency. There will be less coil movement, and increased resistance to moisture, due to better varnish retention. Even though these improvements are difficult for the service shop to quantify, they are nonetheless real and will usually improve motor performance and reliability. With this modification, the motor's service factor will be improved and it will be able to withstand wider variations in voltage, ambient and starting conditions.

Reconnection

The service center can often reconnect an existing winding to reduce starting current and torque. To reduce starting torque, a wye-start/delta-run connection can be used. In some cases a motor can be reconnected, while in other cases a rewind is required. Other starting options include a variable frequency drive (also known as VSD) or a solid-state soft-starter.

There will always be applications where reduced starting current will be required. In most cases a Design A motor, even with its inherent higher starting current will still be justified, when coupled with an appropriate starter sized for the current. Typical paybacks when comparing reduced energy consumption savings against capital investment range between 1 and 3 years, based on the cost of energy and hours of running time. Wye-delta starting reduces inrush current to 37% and provides one-third the starting torque.

Part-winding start methods reduce inrush current to one-half to two-thirds while supplying one-half the starting torque. This method uses only a portion (usually 1/2, but sometimes 2/3) of the motor winding, increasing the impedance seen by the power system. It is to be used only for voltage recovery, and must not be left on the start connection for more than 2 to 3 seconds. The motor is not always expected to accelerate on the start connection, and may not even turn.

The double delta or extended delta connection is the same externally as the typical part-winding start connection, but internally it is different. This method accomplishes the equivalent of reduced-voltage starting by changing a delta-connected winding from parallel groups to series groups during the start. It is frequently termed "double or extended delta, part winding" because it uses a standard part-winding starter and has characteristics that are similar to the part-winding starting. The advantage of this connection is that all of the winding is connected during the start cycle, and the rate of heating is not so severe.

The service center can make the necessary changes in appropriate cases (see Figure 8).

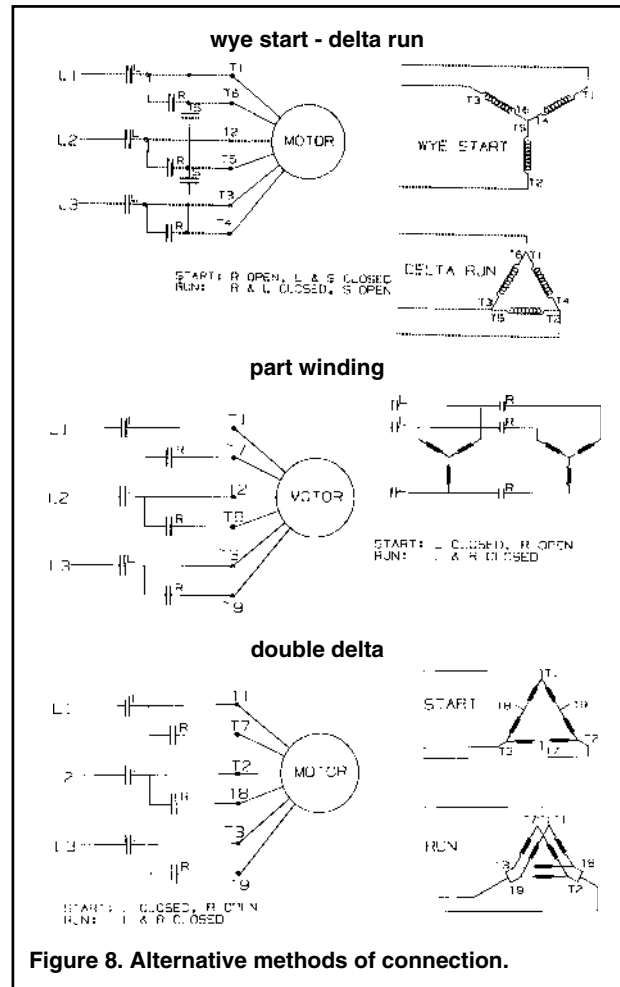

Figure 8. Alternative methods of connection.

Conclusion

The economics of the repair or replace decision process are complex. As many variables as possible must be considered in order to select the best available option.

By incorporating effective technology as it becomes available, it is possible to reduce downtime, improve productivity and operate more efficiently. Reduced costs make an organization more profitable. Savings can be redirected to improve other "weak links." The savvy maintenance professional is always looking for ways to improve processes, and

the competent service center is able to assist in this task.

When evaluating the operating cost of an electric motor, the cost of energy is only one variable in the equation. The key to maximizing productivity is to eliminate downtime. While zero downtime is not always possible, any significant reduction in downtime improves profitability. When downtime costs are high, the payback reaped from extending motor life can be enormous.

The efficiency of an electric motor can be maintained, or in some cases improved, by good practice repair methods. Recognizing those opportunities for improvement, and understanding the repair methods that can impact efficiency, are key to the repair process. Properly done, a motor may be rewound multiple times without degrading the efficiency.

Electrical Apparatus Service Association, Inc.

1331 Baur Blvd.
St. Louis, Missouri 63132 U.S.A.
314-993-2220 • Fax: 314-993-1269
www.easa.com • easainfo@easa.com

Association of Electrical and Mechanical Trades (AEMT Ltd)

Co. Reg. No. 00397289 (England and Wales)
St. Saviours House
St. Saviours Place
York, YO1 7PJ
England, UK
44 (0) 1904 674897 • Fax: 44 (0) 1904 674896
admin@aemt.co.uk • www.aemt.co.uk